



USER GUIDE

Trimble® R8 GNSS Receiver Trimble R6/5800 GPS Receivers





NORTH AMERICA

Trimble Engineering &
Construction Group
5475 Kellenburger Road
Dayton, Ohio 45424-1099 • USA
800-538-7800 (Toll Free)
+1-937-245-5154 Phone
+1-937-233-9441 Fax

EUROPE

Trimble GmbH
Am Prime Parc 11
65479 Raunheim • GERMANY
+49-6142-2100-0 Phone
+49-6142-2100-550 Fax

ASIA-PACIFIC

Trimble Navigation
Singapore Pty Limited
80 Marine Parade Road
#22-06, Parkway Parade
Singapore 449269 • SINGAPORE
+65-6348-2212 Phone
+65-6348-2232 Fax



www.trimble.com

USER GUIDE

Trimble® R8 GNSS Receiver Trimble R6/5800 GPS Receivers

Version 4.00
Revision A
February 2009



Corporate office

Trimble Navigation Limited
Engineering and Construction group
5475 Kellenburger Road
Dayton, Ohio 45424-1099
USA

800-538-7800 (toll free in USA)
+1-937-245-5600 Phone
+1-937-233-9004 Fax
www.trimble.com

Legal notices

© 2004-2009, Trimble Navigation Limited. Trimble, the Globe & Triangle logo, BlueCap, GPS Total Station, and TSC2 are trademarks of Trimble Navigation Limited, registered in the United States and in other countries. CMR+, Digital Fieldbook, Maxwell, Trimble Geomatics Office, Trimble Survey Controller, TRIMMARK, TRIMTALK, and TSCe are trademarks of Trimble Navigation Limited. The Bluetooth word mark and logos are owned by the Bluetooth SIG, Inc. and any use of such marks by Trimble Navigation Limited is under license. Recon is a registered trademark of Tripod Data Systems, Inc. Microsoft, Windows, and Windows NT are either registered trademarks or trademarks of Microsoft Corporation in the United States and/or other countries. All other trademarks are the property of their respective owners.

These products are protected by one or more of the following patents: 4754465, 4847862, 5148179, 5187450, 5202694, 5311149, 5402450, 5493588, 5515057, 5519620, 5486834, 6061632, 6252863, 7432853, 7312747, 7260476, 5523761, 5621416, 5923287, 6031882, 6810324

Release notice

This is the February 2009 release (Revision A) of the *Trimble R8 GNSS and R6/5800 GPS Receivers User Guide*. It applies to version 4.00 of the Trimble R8 GNSS receiver and the Trimble R6/5800 II GPS receivers.

Product Limited Warranty Information

For applicable product Limited Warranty information, please refer to the Limited Warranty Card included with this Trimble product, or consult your local Trimble authorized dealer.

Product Extended Limited Warranty Information

For applicable product Extended Limited Warranty information, please refer to the Limited Warranty Card included with this Trimble product, or consult your Trimble dealer.

Notices

Class B Statement – Notice to Users. This equipment has been tested and found to comply with the limits for a Class B digital device, pursuant to Part 15 of the FCC rules. These limits are designed to provide reasonable protection against harmful interference in a residential installation. This equipment generates, uses, and can radiate radio frequency energy and, if not installed and used in accordance with the instructions, may cause harmful interference to radio communication. However, there is no guarantee that interference will not occur in a particular installation. If this equipment does cause harmful interference to radio or television reception, which can be determined by turning the equipment off and on, the user is encouraged to try to correct the interference by one or more of the following measures:

- Reorient or relocate the receiving antenna.
- Increase the separation between the equipment and the receiver.
- Connect the equipment into an outlet on a circuit different from that to which the receiver is connected.
- Consult the dealer or an experienced radio/TV technician for help.

Changes and modifications not expressly approved by the manufacturer or registrant of this equipment can void your authority to operate this equipment under Federal Communications Commission rules.

Canada

This digital apparatus does not exceed the Class B limits for radio noise emissions from digital apparatus as set out in the radio interference regulations of the Canadian Department of Communications.

Le présent appareil numérique n'émet pas de bruits radioélectriques dépassant les limites applicables aux appareils numériques de Classe B prescrites dans le règlement sur le brouillage radioélectrique édicté par le Ministère des Communications du Canada.

Europe

This product has been tested and found to comply with the essential requirements for a Class B device pursuant to European Council Directive 1999/5/EC on R&TTE on EMC, thereby satisfying the requirements for CE Marking and sale within the European Economic Area (EEA). These requirements are designed to provide reasonable protection against harmful interference when the equipment is operated in a residential or commercial environment. The 450 MHz band is not harmonised across the European Community.



Australia and New Zealand

This product conforms with the regulatory requirements of the Australian Communications and Media Authority (ACMA) EMC framework, thus satisfying the requirements for C-Tick Marking, A-Tick Marking and sale within Australia and New Zealand.



Taiwan – Battery Recycling Requirements

The product contains a removable Lithium-ion battery. Taiwanese regulations require that waste batteries be recycled.



廢電池請回收

Notice to Our European Union Customers

For product recycling instructions and more information, please go to www.trimble.com/ev.shtml.

Recycling in Europe: To recycle Trimble WEEE (Waste Electrical and Electronic Equipment, products that run on electrical power), Call +31 497 53 24 30, and ask for the "WEEE Associate". Or, mail a request for recycling instructions to:



Trimble Europe BV
c/o Menlo Worldwide Logistics
Meerheide 45
5521 DZ Eersel, NL

FCC Declaration of Conformity

We, Trimble Navigation Limited,

935 Stewart Drive
PO Box 3642
Sunnyvale, CA 94088-3642
United States
+1-408-481-8000

declare under sole responsibility that the products:
Trimble R8 GNSS receiver and Trimble R6/5800 GPS receivers
comply with Part 15 of FCC Rules.

Operation is subject to the following two conditions:
(1) this device may not cause harmful interference, and
(2) this device must accept any interference received, including interference that may cause undesired operation.

RTTE Compliance statements

Czech	Trimble Navigation Limited tímto prohlašuje, že tento [Trimble R8 GNSS / Trimble R6/5800 GPS] je ve shodě se základními požadavky a dalšími příslušnými ustanoveními směrnice 1999/5/ES.
Danish	Undertegnede Trimble Navigation Limited erklærer herved, at følgende udstyr [Trimble R8 GNSS / Trimble R6/5800 GPS] overholder de væsentlige krav og øvrige relevante krav i direktiv 1999/5/EF.
Dutch	Hierbij verklaart Trimble Navigation Limited dat het toestel [Trimble R8 GNSS / Trimble R6/5800 GPS] in overeenstemming is met de essentiële eisen en de andere relevante bepalingen van richtlijn 1999/5/EG.
English	Hereby, Trimble Navigation Limited, declares that this equipment [Trimble R8 GNSS / Trimble R6/5800 GPS] is in compliance with the essential requirements and other relevant provisions of Directive 1999/5/EC.
Estonian	Käesolevaga kinnitab Trimble Navigation Limited seadme [Trimble R8 GNSS / Trimble R6/5800 GPS] vastavust direktiivi 1999/5/EÜ põhinõuetele ja nimetatud direktiivist tulenevatele teistele asjakohastele sätetele.
German	Hiermit erklärt Trimble Navigation Limited, dass sich das Gerät [Trimble R8 GNSS / Trimble R6/5800 GPS] in Übereinstimmung mit den grundlegenden Anforderungen und den übrigen einschlägigen Bestimmungen der Richtlinie 1999/5/EG befindet.
Greek	ΜΕ ΤΗΝ ΠΑΡΟΥΣΑ Trimble Navigation Limited ΔΗΛΩΝΕΙ ΟΤΙ [Trimble R8 GNSS / Trimble R6/5800 GPS] ΣΥΜΜΟΡΦΩΝΕΤΑΙ ΠΡΟΣ ΤΙΣ ΟΥΣΙΩΔΕΙΣ ΑΠΑΙΤΗΣΕΙΣ ΚΑΙ ΤΙΣ ΛΟΙΠΕΣ ΣΧΕΤΙΚΕΣ ΔΙΑΤΑΞΕΙΣ ΤΗΣ ΟΔΗΓΙΑΣ 1999/5/ΕΚ.
Hungarian	Alulírott, Trimble Navigation Limited nyilatkozom, hogy a [Trimble R8 GNSS / Trimble R6/5800 GPS] megfelel a vonatkozó alapvető követelményeknek és az 1999/5/EC Irányelv egyéb előírásainak.
Finnish	Trimble Navigation Limited vakuuttaa täten että [Trimble R8 GNSS / Trimble R6/5800 GPS] tyyppinen laite on direktiivin 1999/5/EY oleellisten vaatimusten ja sitä koskevien direktiivin muiden ehtojen mukainen.
French	Par la présente Trimble Navigation Limited déclare que l'appareil [Trimble R8 GNSS / Trimble R6/5800 GPS] est conforme aux exigences essentielles et aux autres dispositions pertinentes de la directive 1999/5/CE.
Icelandic	Hér með lýsir Trimble Navigation Limited yfir því að [Trimble R8 GNSS / Trimble R6/5800 GPS] er í samræmi við grunnkröfur og aðrar kröfur, sem gerðar eru í tilskipun 1999/5/EC
Italian	Con la presente Trimble Navigation Limited dichiara che questo [Trimble R8 GNSS / Trimble R6/5800 GPS] è conforme ai requisiti essenziali ed alle altre disposizioni pertinenti stabilite dalla direttiva 1999/5/CE.
Latvian	Ar šo Trimble Navigation Limited deklarē, ka [Trimble R8 GNSS / Trimble R6/5800 GPS] atbilst Direktīvas 1999/5/EK būtiskajām prasībām un citiem ar to saistītajiem noteikumiem.
Lithuanian	Šiuo Trimble Navigation Limited deklaruoja, kad šis [Trimble R8 GNSS / Trimble R6/5800 GPS] atitinka esminius reikalavimus ir kitas 1999/5/EB Direktyvos nuostatas.
Maltese	Hawn hekk, Trimble Navigation Limited, jiddikjara li dan [Trimble R8 GNSS / Trimble R6/5800 GPS] jikkonforma mal-htigijiet essenzjali u ma provvedimenti oħrajn relevanti li hemm fid-Direttiva 1999/5/EC.
Norwegian	Trimble Navigation Limited erklærer herved at utstyret [Trimble R8 GNSS / Trimble R6/5800 GPS] er i samsvar med de grunnleggende krav og øvrige relevante krav i direktiv 1999/5/EF.
Polish	Niniejszym Trimble Navigation Limited oświadczam, że [Trimble R8 GNSS / Trimble R6/5800 GPS] jest zgodny z zasadniczymi wymogami oraz pozostałymi stosownymi postanowieniami Dyrektywy 1999/5/EC
Portuguese	Trimble Navigation Limited declara que este [Trimble R8 GNSS / Trimble R6/5800 GPS] está conforme com os requisitos essenciais e outras disposições da Directiva 1999/5/CE.
Slovak	Trimble Navigation Limited týmto vyhlasuje, že [Trimble R8 GNSS / Trimble R6/5800 GPS] spĺňa základné požiadavky a všetky príslušné ustanovenia Smernice 1999/5/ES.
Slovenian	Trimble Navigation Limited izjavlja, da je ta [Trimble R8 GNSS / Trimble R6/5800 GPS] v skladu z bistvenimi zahtevami in ostalimi relevantnimi določili direktive 1999/5/ES.
Spanish	Por medio de la presente Trimble Navigation Limited declara que el [Trimble R8 GNSS / Trimble R6/5800 GPS] cumple con los requisitos esenciales y cualesquiera otras disposiciones aplicables o exigibles de la Directiva 1999/5/CE.
Swedish	Härmed intygar Trimble Navigation Limited att denna [Trimble R8 GNSS / Trimble R6/5800 GPS] står i överensstämmelse med de väsentliga egenskapskrav och övriga relevanta bestämmelser som framgår av direktiv 1999/5/EG.

Safety Information

This manual describes the Trimble® R8 GNSS and R6/5800 II GPS receivers. Unless otherwise specified, “the receiver” refers to all receivers covered in this User Guide.

Note – To determine if you have a **5800 II** GPS receiver, look underneath for a label that shows the part number and the product name.

Before you use your receiver make sure that you have read and understood this publication, as well as all safety requirements.

Warnings and Cautions

An absence of specific alerts does not mean that there are no safety risks involved.

Always follow the instructions that accompany a Warning or Caution. The information they provide is intended to minimize the risk of personal injury and/or damage to the equipment. In particular, observe safety instructions that are presented in the following formats:



WARNING – A Warning alerts you to a likely risk of serious injury to your person and/or damage to the equipment. A warning identifies the nature of the risk and the extent of possible injury and/or damage. It also describes how to protect yourself and/or the equipment from this risk. Warnings that appear in the text are repeated at the front of the manual.



CAUTION – A Caution alerts you to a possible risk of damage to the equipment and/or loss of data. A Caution describes how to protect the equipment and/or data from this risk.

Regulations and safety

The receivers contain integral Bluetooth® wireless technology, and may also send radio signals through the antenna of an internal radio-modem, or through an externally-connected data communications radio. Regulations regarding the use of the 450 MHz radio-modems vary greatly from country to country. In some countries, the unit can be used without obtaining an end-user license. Other countries require end-user licensing. For licensing information, consult your local Trimble dealer. Bluetooth operates in license-free bands.

Type approval

Type approval, or acceptance, covers technical parameters of the equipment related to emissions that can cause interference. Type approval is granted to the manufacturer of the transmission equipment, independent from the operation or licensing of the units. Some countries have unique technical requirements for operation in particular

radio-modem frequency bands. To comply with those requirements, Trimble may have modified your equipment to be granted Type approval. Unauthorized modification of the units voids the Type approval, the warranty, and the operational license of the equipment.

Operation near other radio equipment

When operating the receiver in member states of the European Union and in other countries which adhere to the EU R&TTE requirements, while in the vicinity of aeronautical radionavigation equipment operating between 2700 and 2900 MHz, or Fixed, Fixed Satellite (space to Earth) or Mobile systems operating at 4170 MHz, a minimum separation of 5 meters must be maintained between the receiver and such radio equipment.

Exposure to radio frequency radiation

For 450 MHz radio

Safety. Exposure to RF energy is an important safety consideration. The FCC has adopted a safety standard for human exposure to radio frequency electromagnetic energy.

Proper use of this radio modem results in exposure below government limits. The following precautions are recommended:

- **DO NOT** operate the transmitter when someone is within 20 cm (7.8 inches) of the antenna.
- **DO NOT** collocate (place within 20 cm) the radio antenna with any other transmitting antenna.
- **DO NOT** operate the transmitter unless all RF connectors are secure and any open connectors are properly terminated.
- **DO NOT** operate the equipment near electrical blasting caps or in an explosive atmosphere.
- All equipment must be properly grounded according to Trimble installation instructions for safe operation.
- All equipment should be serviced only by a qualified technician.

For GSM radio



CAUTION – For your own safety, and in terms of the RF Exposure requirements of the FCC, always observe the precautions listed here.

- Always maintain a minimum separation distance of 20 cm (7.8 inches) between yourself and the radiating antenna on the Trimble R8 GNSS or the Trimble R6

radio-modem.

- Do not collocate (place within 20 cm) the radio antenna with any other transmitting antenna.
-

For Bluetooth radio

The radiated output power of the internal Bluetooth wireless radio is far below the FCC radio frequency exposure limits. Nevertheless, the wireless radio shall be used in such a manner that the Trimble receiver is 20 cm or further from the human body. The internal wireless radio operates within guidelines found in radio frequency safety standards and recommendations, which reflect the consensus of the scientific community. Trimble therefore believes the internal wireless radio is safe for use by consumers. The level of energy emitted is far less than the electromagnetic energy emitted by wireless devices such as mobile phones. However, the use of wireless radios may be restricted in some situations or environments, such as on aircraft. If you are unsure of restrictions, you are encouraged to ask for authorization before turning on the wireless radio.

Installing antennas



CAUTION – For your own safety, and in terms of the RF Exposure requirements of the FCC, always observe these precautions:

- Always maintain a minimum separation distance of 20 cm (7.8 inches) between yourself and the radiating antenna.
 - Do not collocate (place within 20cm) the radio antenna with any other transmitting device.
-

This device has been designed to operate with the antennas listed below.

UHF Antennas not included in this list, or that have a gain greater than 5 dBi, are strictly prohibited for use with this device. The required antenna impedance is 50 ohms.

The antennas that can be used (country dependent) with the **450 MHz radio** are 0 dBi and 5 dBi whip antennas.

The antenna that can be used with the **GSM radio** is the 0 dBi whip antenna.

To reduce potential radio interference to other users, the antenna type and its gain should be so chosen that the equivalent isotropically radiated power (e.i.r.p.) is not more than that permitted for successful communication.

Rechargeable Lithium-ion batteries

These receivers use a rechargeable Lithium-ion battery.



WARNING – Do not damage the rechargeable Lithium-ion battery. A damaged battery can cause an explosion or fire, and can result in personal injury and/or property damage.

To prevent injury or damage:

- Do not use or charge the battery if it appears to be damaged. Signs of damage include, but are not limited to, discoloration, warping, and leaking battery fluid.
 - Do not expose the battery to fire, high temperature, or direct sunlight.
 - Do not immerse the battery in water.
 - Do not use or store the battery inside a vehicle during hot weather.
 - Do not drop or puncture the battery.
 - Do not open the battery or short-circuit its contacts.
-



WARNING – Avoid contact with the rechargeable Lithium-ion battery if it appears to be leaking. Battery fluid is corrosive, and contact with it can result in personal injury and/or property damage.

To prevent injury or damage:

- If the battery leaks, avoid contact with the battery fluid.
 - If battery fluid gets into your eyes, immediately rinse your eyes with clean water and seek medical attention. Do not rub your eyes!
 - If battery fluid gets onto your skin or clothing, immediately use clean water to wash off the battery fluid.
-



WARNING – Charge and use the rechargeable Lithium-ion battery only in strict accordance with the instructions. Charging or using the battery in unauthorized equipment can cause an explosion or fire, and can result in personal injury and/or equipment damage.

To prevent injury or damage:

- Do not charge or use the battery if it appears to be damaged or leaking.
 - Charge the Lithium-ion battery only in a Trimble product that is specified to charge it. Be sure to follow all instructions that are provided with the battery charger.
 - Discontinue charging a battery that gives off extreme heat or a burning odor.
 - Use the battery only in Trimble equipment that is specified to use it.
 - Use the battery only for its intended use and according to the instructions in the product documentation.
-

Other Warnings



WARNING – Operating or storing the receiver outside the specified temperature range can damage it. For more information, see [Physical specifications, page 50](#).

Contents

	Safety Information	5
	Warnings and Cautions	5
	Regulations and safety	5
	Type approval	5
	Operation near other radio equipment	6
	Exposure to radio frequency radiation	6
	For 450 MHz radio	6
	For GSM radio	6
	For Bluetooth radio	7
	Installing antennas	7
	Rechargeable Lithium-ion batteries	8
	Other Warnings	8
1	Introduction	13
	Related information	13
	Technical assistance	14
	Your comments	14
2	Overview	15
	Features	16
	Use and care	16
	COCOM limits	17
3	Setting up the Receiver	19
	Parts of the receiver	20
	Front panel	20
	Lower housing	21
	Setup guidelines	22
	Operation near other radio equipment	22
	Environmental conditions	22
	Sources of electrical interference	23
	General guidelines	23
	Pole-mounted setup	23
	Other system components	25
	Radios	25
	Cellular modems and external radios	26
4	General Operation	27
	Front panel controls	28
	Button functions	28
	LED behavior	29
	LED flash patterns	29
	Starting and stopping the receiver	29

Logging data	30
Logging internally	30
Logging to a Trimble controller	31
Resetting to defaults	31
Batteries and power	31
Battery charging and storage	32
Power output	33
Firmware	33
5 Configuration	35
Configuring the receiver in real time	36
Configuring the receiver using application files	36
Application files	36
Special application files	37
Applying application files	38
Storing application files	38
Naming application files	39
6 Software Utilities	41
The GPS Configurator software	42
Installing the GPS Configurator software	42
The WinFlash Utility	43
Installing the WinFlash utility	43
Upgrading firmware	43
Adding frequencies for the 450 MHz internal radio	44
Configuring the internal transceiver	46
7 Specifications	49
Physical specifications	50
Positioning specifications	50
Technical specifications	51
8 Default Settings	53
Default settings	54
Resetting to factory defaults	54
Default behavior	55
Power up settings	55
9 Cables and Connectors	57
Port 1 and 2 connectors	58
Power/serial data cables	59
A NMEA-0183 Output	61
NMEA-0183 Outputs	62
Common Message Elements	63
Message values	63

NMEA Messages	63
B RTCM Output	73
Generated messages	74
Message scheduling	74
C Troubleshooting	75
LED conditions	76
Receiver issues.	76
Index.	79

Introduction

Welcome to the *Trimble R8 GNSS and R6/5800 GPS Receivers User Guide*. This manual describes how to install, set up, and use a Trimble® R8 GNSS receiver or a Trimble R6/5800 II GPS receiver.

Unless otherwise specified, “the receiver” refers to all receivers covered in this User Guide.

Note – *To determine if you have a 5800 II GPS receiver, look underneath for a label that shows the part number and the product name.*

Even if you have used other Global Positioning System (GPS) products before, Trimble recommends that you spend some time reading this manual to learn about the special features of your receiver.

If you are not familiar with GPS, visit our website for an interactive look at Trimble and GPS at www.trimble.com

Trimble assumes that you are familiar with the Windows® operating system and know how to use a mouse, select options from menus and dialogs, make selections from lists, and refer to online help.

Related information

An electronic copy of this manual is available in portable document format (PDF) on the receiver CD-ROM. Use Adobe Reader to view the contents of this file.

Other sources of related information are:

- Release notes – the release notes describe new features of the product, information not included in the manual, and any changes to the manual. They are provided as a PDF on the CD. Use Adobe Reader to view the contents of the release notes.
- Registration – register your receiver to automatically receive e-mail notifications of receiver firmware upgrades and new functionality. To register, do one of the following:
 - Run the receiver CD.
 - Register electronically at www.trimble.com.
 - Print the registration form that is on the CD, fill it in, and fax or mail it to the address shown.Contact your local Trimble Dealer for more information about the support agreement contracts for software and firmware, and an extended warranty program for hardware.
- Trimble training courses – consider a training course to help you use your GPS system to its fullest potential. For more information, visit the Trimble website at www.trimble.com/training.html.

Technical assistance

If you have a problem and cannot find the information you need in the product documentation, *contact your local Dealer*. Alternatively, request technical support using the Trimble website at (www.trimble.com/support.html).

Your comments

Your feedback about the supporting documentation helps us to improve it with each revision. E-mail your comments to ReaderFeedback@trimble.com.

Overview

In this chapter:

- [Features](#)
- [Use and care](#)
- [COCOM limits](#)

This chapter introduces the Trimble R8 GNSS and R6/5800 GPS receivers for GPS surveying applications.

Unless otherwise specified, “the receiver” refers to all receivers covered in this User Guide.

The receiver incorporates a GPS antenna, receiver, internal radio with a transmit option or an internal GSM module, and a battery in a rugged light-weight unit that is ideally suited as an all-on-the-pole RTK rover. Three LEDs allow you to monitor the satellite tracking, radio reception, data logging status, and power. Bluetooth wireless technology provides cable-free communications between receiver and controller.

- The circuitry in the Trimble R8 GNSS receivers provide up to 220 channels (based on installed options) for satellite tracking and support, and to log raw GPS observables to the handheld controller for postprocessed applications.
- The Trimble R6 GPS receivers provide 72 channels for satellite tracking and support, and to log raw GPS observables to the handheld controller for postprocessed applications.
- The 5800 II GPS receiver provides 24 channels for satellite tracking, and supports logging raw GPS observables to the handheld controller for postprocessed applications.

The receiver is available as a standalone rover, base station, or as part of the GPS Total Station® system, offering maximum versatility in the system configuration to meet your specific requirements.

Features

The receiver provides the following features:

- Trimble R-track technology, which allows the receivers to track the following:
 - GLONASS (Trimble R6 GPS and Trimble R8 GNSS receivers)
 - L2C and L5 (Trimble R8 GNSS receiver)
- Centimeter-accuracy, real-time positioning with RTK/OTF data, up to 10 Hz position updates
- Submeter-accuracy, real-time positioning using pseudorange corrections
- Adaptive dual-frequency RTK engine
- WAAS/EGNOS capability (Wide Area Augmentation System/European Geo-Stationary Navigation System)
- Automatic OTF (on-the-fly) initialization while moving
- Single Lithium-ion rechargeable battery
- Cable-free Bluetooth communications with the Trimble controllers
- Two RS-232 serial ports for:
 - NMEA output
 - RTCM SC-104 input and output
 - Trimble Format (CMR+™) input and output
- One TNC radio antenna connector
- Internal memory for data storage
- Internal 450 MHz radio with a transmit option or GSM module options

Use and care

The receiver can withstand the rough treatment that typically occurs in the field. However, it is a high-precision electronic instrument and should be treated with reasonable care.



WARNING – Operating or storing the receiver outside the specified temperature range can damage it. For more information, see [Chapter 7, Specifications](#).

High-power signals from a nearby radio or radar transmitter can overwhelm the receiver circuits. This does not harm the instrument, but it can prevent the receiver electronics from functioning correctly. Avoid using the receiver within 400 meters of powerful radar, television, or other transmitters. Low-power transmitters such as those used in cellphones and two-way radios normally do not interfere with receiver operations.

For more information, contact your local Trimble distributor.

COCOM limits

The U.S. Department of Commerce requires that all exportable GPS products contain performance limitations so that they cannot be used in a manner that could threaten the security of the United States. The following limitations are implemented on the receiver.

Immediate access to satellite measurements and navigation results is disabled when the receiver's velocity is computed to be greater than 1000 knots, or its altitude is computed to be above 18,000 meters. The receiver continuously resets until the COCOM situation is cleared.

Setting up the Receiver

This chapter provides general information on setup, connection, and cabling for the most common uses of the receiver.

In this chapter:

- Parts of the receiver
- Setup guidelines
- Pole-mounted setup
- Other system components

Parts of the receiver

All operating controls on the receiver are located on the front panel. Serial ports and connectors are located on the bottom of the unit.

Front panel

Figure 3.1 shows the receiver front panel, which contains the three indicator light emitting diodes (LEDs), and the power button.



Figure 3.1 Receiver front panel

The power button controls the receiver's power on or off functions.

The indicator LEDs show the status of power, satellite tracking, and radio reception. For more information, see [LED behavior, page 29](#).

Lower housing

Figure 3.2 shows the receiver lower housing, which contains the two serial ports, one TNC radio antenna or GSM antenna connector (depending on the internal communication module ordered), the removable battery compartment and the 5/8-11 threaded insert.

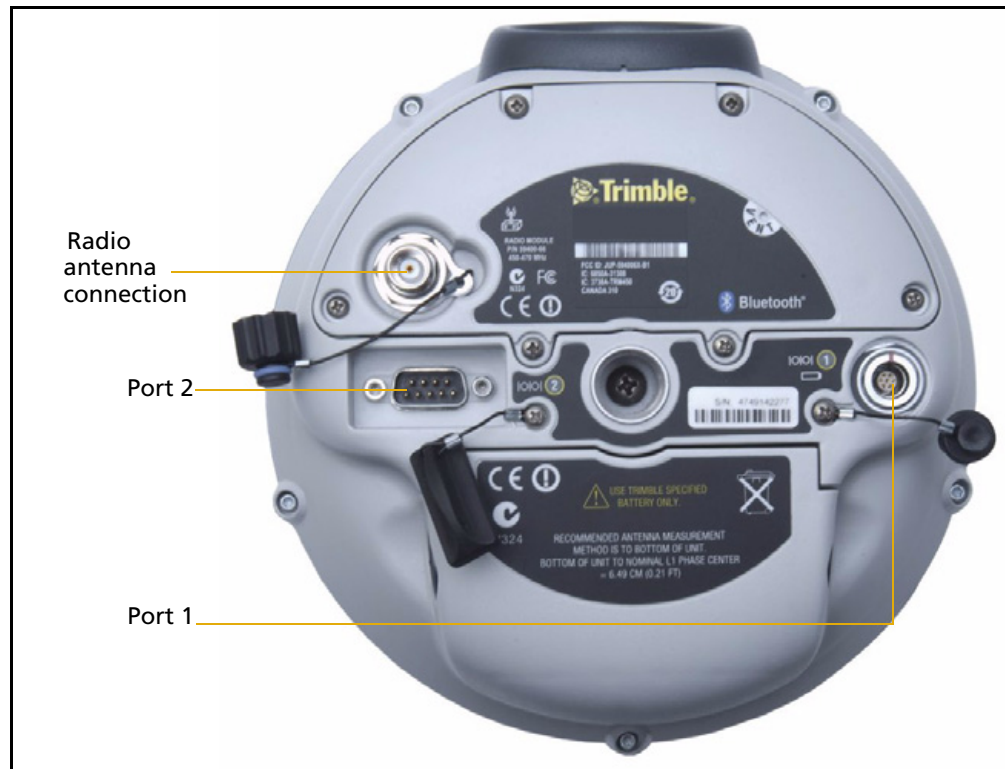





Figure 3.2 Receiver lower housing

Each port or connector on the receiver is marked with an icon to indicate its main function as shown below.

Icon	Name	Connections
	Port 1	Device, computer, external radio, power in
	Port 2	Device, computer, external radio
	RADIO	Radio communications antenna

Port 1 is a 7-pin 0-shell Lemo connector that supports RS-232 comms and external power input. Port 1 has no power outputs.

Port 2 is a DB-9 male connector that allows for full 9-pin RS-232 comms. Port 2 does not support power in or out. For more information, see [Chapter 8, Default Settings](#) and [Chapter 9, Cables and Connectors](#).

The TNC connector is for connecting a radio antenna to the receiver internal radio. A whip “rubber duck” antenna is supplied with the system for units with internal UHF radios. This connector is not used if you are using an external UHF radio or GSM.

External UHF or GSM antenna

Depending on which module you have purchased, use this TNC connection for an external antenna to enhance the UHF or GSM.

The UHF and GSM antennas are both approximately 16.5 cm long. The UHF antennas have color coded dots on the top where the GSM antenna has a black cap.

For more information on connecting the receiver, see the following sections in this chapter.

Setup guidelines

Consider the following guidelines when setting up the receiver.



CAUTION – To satisfy the RF Exposure requirements of the FCC, you must maintain a minimum separation distance of 20 cm (approximately 8 in.) between yourself and the radiating GSM antenna for this device.
For mobile operation, the maximum gain of the GSM antenna must not exceed 0 dBi.

Operation near other radio equipment

When operating the receiver in member states of the European Union and in other countries which adhere to the EU R&TTE requirements, while in the vicinity of aeronautical radionavigation equipment operating between 2700 and 2900 MHz, or Fixed, Fixed Satellite (space to Earth) or Mobile systems operating at 4170 MHz, a minimum separation of 5 meters must be maintained between the receiver and such radio equipment.

Environmental conditions

Although the receiver has a waterproof housing, take reasonable care to protect the unit. Avoid exposure to extreme environmental conditions, including:

- Water
- Heat greater than 65 °C (149 °F)
- Cold less than -40 °C (-40 °F)
- Corrosive fluids and gases

Sources of electrical interference

Avoid the following sources of electrical and magnetic noise:

- Gasoline engines (spark plugs)
- Televisions and PC monitors
- Alternators and generators
- Electric motors
- Equipment with DC-to-AC converters
- Fluorescent lights
- Switching power supplies

General guidelines



WARNING – These receivers use a rechargeable Lithium-ion battery. To avoid personal injury or equipment damage, make sure that you read and understand the [Safety Information](#) on [page 5](#) at the front of this manual.

The following guidelines apply whenever you set up the receiver for operation:

- When plugging in a Lemo cable, make sure that the red dots on the receiver port and the cable connector line up. **Do not** use force to plug cables in, as this may damage the connector pins.
- When disconnecting a Lemo cable, grasp the cable by the sliding collar or lanyard and then pull the cable connector straight out of the port. Do not twist the connector or pull on the cable itself.
- To securely connect a TNC cable, align the cable connector with the receiver receptacle and then thread the cable connector onto the receptacle until it is snug.
- To insert the internal battery, place the battery in the battery compartment, ensuring that the contact points are in the correct position to align with the contacts in the receiver. Slide the battery and compartment as a unit upward into the receiver until the battery compartment latches are locked into position.

Pole-mounted setup

[Figure 3.3 on page 24](#) shows the pole-mounted setup for the receiver. To mount the receiver on a range pole:

1. Thread the receiver onto the range pole.
2. Attach the controller bracket to the pole.
3. Insert the controller into the bracket.

Note – When using a Trimble TCU, Trimble Recon[®], TSCe[™] with BlueCap[®], or a TSC2 controller, no cabling is required, as shown in [Figure 3.3](#).

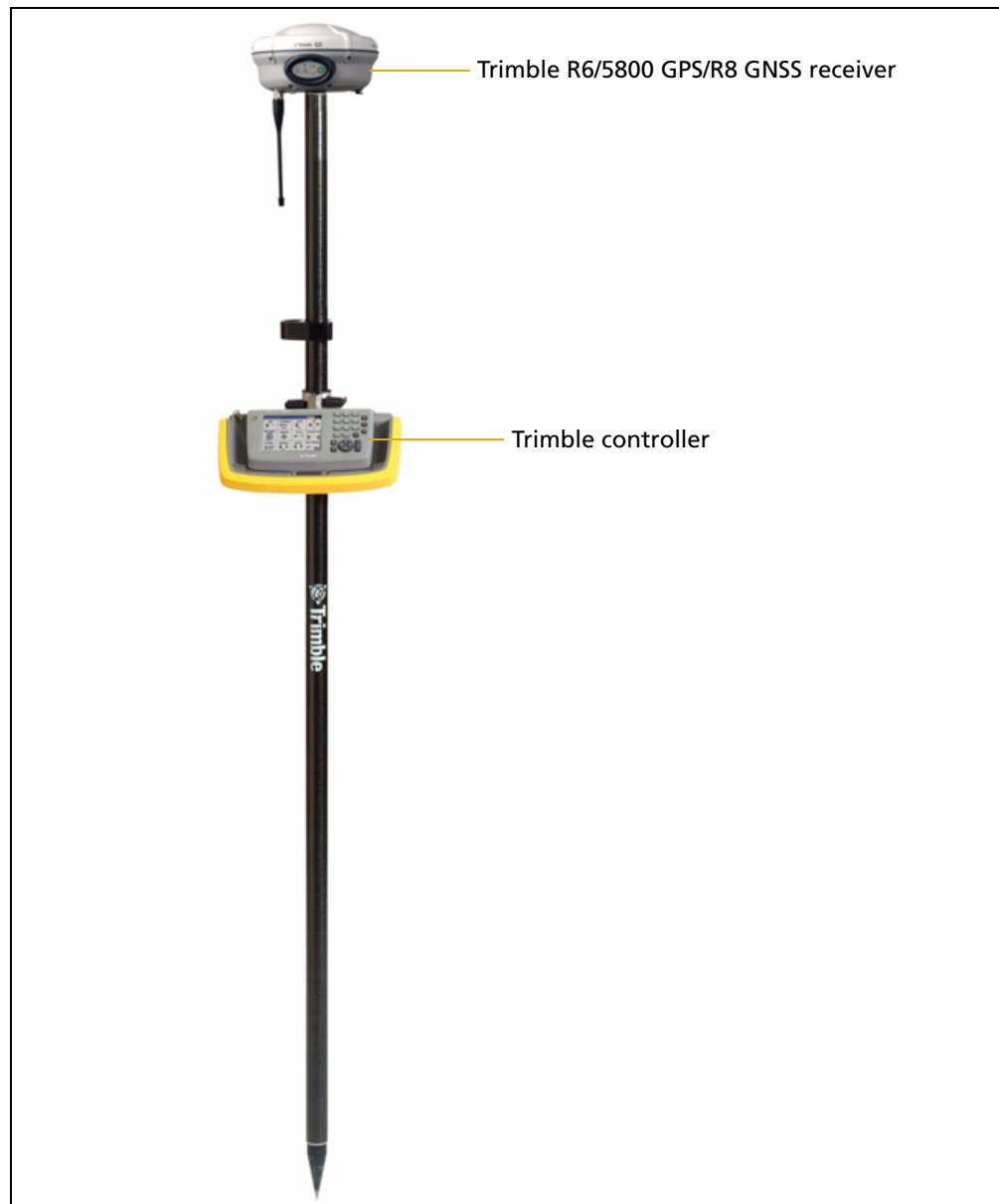

Figure 3.3 Receiver pole-mounted setup

Other system components

This section describes optional components that you can use with the receiver.

Radios

Radios are the most common data link for Real-Time Kinematic (RTK) surveying. The receiver is available with an optional internal radio in the 450 MHz UHF band, or with an internal GSM module (Trimble R8 GNSS / R6 GPS receivers only). You can also connect an external radio to either receiver port, whether or not the internal radio is installed.

The receiver supports the following Trimble base radios with the internal 450 MHz radio:

- Trimble HPB450
- Trimble PDL450
- Receiver internal 450 MHz transmitter
- TRIMMARK™ 3 radio
- SiteNet™ 450 radio

Internal GSM setup

You can configure the optional internal GSM Module using the Trimble Survey Controller™ software. For more information, refer to the *Trimble Survey Controller User Guide*.

Internal radio setup

To configure the receiver optional internal radio, use one of the following:

- The GPS Configurator software
- The WinFlash utility
- The Trimble Survey Controller software
- The Trimble Digital Fieldbook™ software

For more information, refer to the documentation for these applications.

By default, the internal radio has only a few “test” frequencies installed at the factory. If you purchased the transmit option, the broadcast frequencies must be programmed at the factory. You can program the receive frequencies using the WinFlash utility. For more information, see [The WinFlash Utility, page 43](#).

Note – *A Frequency Configuration sheet accompanies every receiver order that contains the transmit option.*

Cellular modems and external radios

For a data communications link, you can use an internal or external radio, or an internal or external cellular modem.

To connect an external cellular modem to the receiver, you need the following:

- A Trimble R8 GNSS or R6/5800 GPS receiver.
- A cellular modem, or a cellphone that can transmit and receive data.
- Serial (cellphone to DB9) cable (supplied with the cellular modem or phone).

***Note** – For more information, refer to the document *Using Cellular and CDPD Modems for RTK*, which is available from your local Trimble Reseller.*

- Port 2 of the receiver supports full RS-232 protocol, and should function properly with most cellular phone cables. Some cellular units may require custom cabling.

Alternatively, the receiver also supports a cable-free Bluetooth connection with Bluetooth-enabled cell phones.

For more information on using an external cellular modem as a data link, refer to the *Trimble Survey Controller User Guide*.

To connect an external radio modem to a receiver, you need the following:

- A receiver.
- An external radio capable of receiving and decoding Trimble data packets.
- Serial cable for either Port 1 or Port 2 of the receiver, as supplied by the radio manufacturer.
- Radio mount for the range pole.

General Operation

In this chapter:

- [Button functions](#)
- [LED behavior](#)
- [Starting and stopping the receiver](#)
- [Logging data](#)
- [Resetting to defaults](#)
- [Batteries and power](#)

All the controls that you need for general receiver operation are on the front panel.

For more information about other receiver panels, see [Parts of the receiver, page 20](#).

Front panel controls

Figure 4.1 shows the receiver front panel controls for the power on/off functions, or receiver reset. The LEDs provide power, radio, data logging, and SV tracking status information.

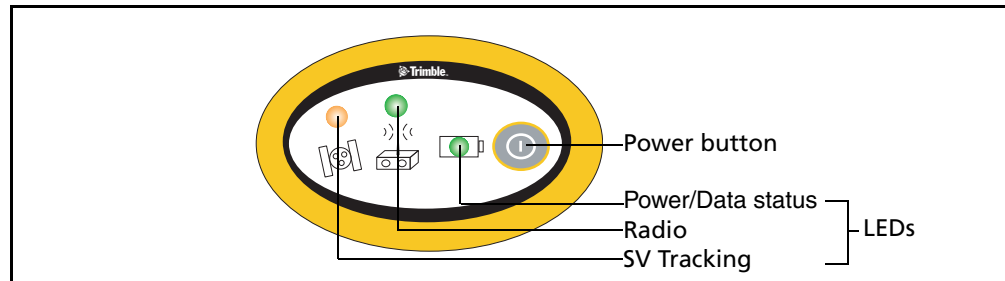

Figure 4.1 Receiver front panel controls and LEDs

Button functions

The receiver has only one button, the Power button. Press the Power button to turn on or turn off the receiver, and to perform other functions, as described below.



CAUTION – Do not hold down the power button for more than 30 seconds. After 30 seconds, any application files stored in the receiver are deleted.

Table 4.1 Power button functions

To ...	Power button
turn on the receiver	Press
turn off the receiver	Hold for 2 seconds
delete the ephemeris file	Hold for 15 seconds
reset the receiver to factory defaults	Hold for 15 seconds
delete application files	Hold for 30 seconds

Note – The term “press” means to press the button and release it immediately. The term “hold” means to press the button and hold it down for the given time.

LED behavior

The three LEDs on the front panel of the receiver indicate various operating conditions. Generally, a lit or slowly flashing LED indicates normal operation, a LED that is flashing quickly indicates a condition that may require attention, and an unlit LED indicates that no operation is occurring. The following table defines each possible LED state.

The term ...	means that the LED ...
Slow flash	alternates on/off for 500 milliseconds.
Fast flash	alternates rapidly on/off for 100 milliseconds
On	is lit
Off	is unlit

LED flash patterns

The following table details the possible flash patterns to indicate various states of receiver operation.

Receiver mode	Power LED Green	Radio LED Green	Satellite LED Amber
Receiver OFF	OFF	OFF	OFF
Receiver ON:			
Healthy power	ON	N/A	N/A
Low power	Fast flash	N/A	N/A
Tracking <4 SVs	ON	N/A	Fast flash
Tracking >4 SVs	ON	N/A	Slow flash
Logging data internally	Flashes off every 3 seconds	N/A	N/A
Transmitting internally	N/A	Flashes off when transmitting	N/A
Receiving valid data packets	ON	Slow flash	N/A
No data packets	ON	OFF	N/A
Receiver in Monitor	ON	Slow flash	ON

Note – If a column shows “N/A”, that specific LED may or may not be on, but it is not relevant to that particular mode.

Starting and stopping the receiver

To turn on the receiver, press the Power button.

To turn off the receiver, hold down the Power button for two seconds.

Logging data

You can log data internally or to a Trimble controller.

Logging internally

The receiver logs raw data on internal memory.

You can then use the Trimble Data Transfer utility or Trimble Business Center software to transfer logged data files to the office computer.

Note – *If you use the Data Transfer utility to download the internally-logged files, you lose any collected GLONASS data. Consider this if you plan to use the Trimble Geomatics Office™ software to process the *.dat files because that software does not process GLONASS data.*

*If you have the Trimble Business Center software, the *.T01 file that is stored on the receiver can be directly downloaded. The *.T01 files will contain any collected GLONASS data. The Trimble Business Center software can process GLONASS data, if you have purchased that option.*



CAUTION – The receiver allows for a maximum of 200 files on the internal memory. The filenames must be in 8.3 format, otherwise, files copied to the internal memory may cause data corruption or loss of data when logging.

Data is logged using the current logging settings configured in the receiver. Data files logged internally are named automatically.

To begin internal logging, you must use a Trimble controller, or the GPS Configurator software. The receiver does not have a continuously running internal clock when it is turned off, so you can conduct timed survey sessions only if the receiver is turned on and connected to a power source.

When the internal memory is full, the receiver stops logging data, and the Power LED stops flashing and remains on continuously. Existing data files are not overwritten. You can use the Auto-delete option to override this action and automatically delete the oldest files when the receiver memory is full. However, you should use this option with caution because it can result in loss of data.

Approximate storage requirements for different logging rates are shown below. The values shown are for a one-hour logging session with six satellites visible.

Logging rate	Memory required
10 Hz	2,588 KB
1 Hz	335 KB
5 seconds	87 KB
15 seconds	37 KB

Logging to a Trimble controller

When the receiver is connected to a Trimble controller, you can log GPS data from the receiver to the controller, or to a data card inserted in the controller. When you use a Trimble controller, you do not use the receiver's controls. Instead, you use the controller functions to set logging options, specify filenames, and control when logging occurs.

Controller software job files and the corresponding raw data files can be transferred to an office computer using the Trimble Data Transfer utility.

For more information on logging data from a receiver using a Trimble controller, refer to the user guide for your particular controller.

Resetting to defaults

To reset the receiver to its factory default settings, hold down the Power button for at least 15 seconds.

For more information, see [Default settings, page 54](#).

Batteries and power



WARNING – Do not damage the rechargeable Lithium-ion battery. A damaged battery can cause an explosion or fire, and can result in personal injury and/or property damage. To prevent injury or damage:

- Do not use or charge the battery if it appears to be damaged. Signs of damage include, but are not limited to, discoloration, warping, and leaking battery fluid.
- Do not expose the battery to fire, high temperature, or direct sunlight.
- Do not immerse the battery in water.
- Do not use or store the battery inside a vehicle during hot weather.
- Do not drop or puncture the battery.
- Do not open the battery or short-circuit its contacts.

The receiver can be powered by its internal battery or by an external power source connected to Port 1.

If an external power source is connected to Port 1, it is used in preference to the internal battery. When there is no external power source connected, or if the external power supply fails, the internal battery is used.



WARNING – Avoid contact with the rechargeable Lithium-ion battery if it appears to be leaking. Battery fluid is corrosive, and contact with it can result in personal injury and/or property damage.

To prevent injury or damage:

- If the battery leaks, avoid contact with the battery fluid.
- If battery fluid gets into your eyes, immediately rinse your eyes with clean water and

seek medical attention. Do not rub your eyes!

– If battery fluid gets onto your skin or clothing, immediately use clean water to wash off the battery fluid.

The receiver is supplied with two rechargeable Lithium-ion batteries, and a dual battery charger. The two batteries charge sequentially and take approximately four hours each to fully charge.

Battery charging and storage

All battery types discharge over time when they are not being used. Batteries also discharge faster in colder temperatures. If a Lithium-ion battery is to be stored for long periods of time, make sure it is fully charged before storing and re-charged at least every three months.



WARNING – Charge and use the rechargeable Lithium-ion battery only in strict accordance with the instructions. Charging or using the battery in unauthorized equipment can cause an explosion or fire, and can result in personal injury and/or equipment damage.

To prevent injury or damage:

– Do not charge or use the battery if it appears to be damaged or leaking.
– Charge the Lithium-ion battery only in a Trimble product that is specified to charge it.

Be sure to follow all instructions that are provided with the battery charger.

– Discontinue charging a battery that gives off extreme heat or a burning odor.
– Use the battery only in Trimble equipment that is specified to use it.
– Use the battery only for its intended use and according to the instructions in the product documentation.

Charging the Lithium-ion battery

The rechargeable Lithium-ion battery is supplied partially charged. Charge the battery completely before using it for the first time. If the battery has been stored for longer than six months, charge it before use.

To protect the battery from deep discharge (5 V or less), the receiver is designed to switch batteries or cease drawing power when the battery pack discharges to 5.9 V.

A battery that has reached the deep discharge level cannot be recharged and must be replaced. The following recommendations provide optimal performance and extend the life of your batteries:

- Fully charge all new batteries prior to use.
- Do not allow the batteries to discharge below 5 V.
- Keep all batteries on continuous charge when not in use. Batteries may be kept on charge indefinitely without damage to the receiver or batteries.
- Do not store batteries in the receiver or external charger unless power is applied.
- If you must store the batteries, fully charge them before storing and then recharge them at least every three months.

Disposing of the rechargeable Lithium-ion battery

Discharge the Lithium-ion battery before disposing of it. When disposing of the battery, be sure to do so in an environmentally sensitive manner. Adhere to any local and national regulations concerning battery disposal or recycling.

Power output

The receiver does not supply power from either of its two ports.

Firmware

A receiver's *firmware* is the program inside the receiver that controls receiver operations and hardware. You can upgrade the firmware for the receiver using the WinFlash utility provided on the receiver CD.

For more information, see [The WinFlash Utility, page 43](#).



CAUTION – Downgrading the firmware deletes all application files on the receiver.

Configuration

In this chapter:

- [Configuring the receiver in real time](#)
- [Configuring the receiver using application files](#)
- [Application files](#)

The receiver has no controls to change settings. To configure the receiver, use external software such as GPS Configurator, WinFlash, Trimble Survey Controller, or Trimble Digital Fieldbook.

To configure the receiver, do one of the following:

- Configure the receiver in real time.
- Apply the settings in an application file.

This chapter provides a brief overview of each of these methods and describes the contents and use of application files.

Configuring the receiver in real time

GPS Configurator, Trimble Survey Controller, and Trimble Digital Fieldbook software support real-time configuration of the receiver.

When you configure the receiver in real time, you use one of these software applications to specify which settings you want to change. When you apply the changes, the receiver settings change immediately.

Any changes that you apply to the receiver are reflected in the current application file, which is always present in the receiver. The current application file always records the most recent configuration, so if you apply further changes (either in real time or using an application file) the current file is updated and there is no record of the changes that you applied originally.

For more information on configuring the receiver in real time, see [Chapter 6, Software Utilities](#).

Configuring the receiver using application files

An application file contains information for configuring a receiver. To configure a receiver using an application file, you need to create the application file, transfer it to the receiver and then apply the file's settings. The GPS Configurator software does this automatically when you work with application files.

For more information on applying application files, see [Chapter 6, Software Utilities](#).

Application files

An application file is organized into records. Each record stores configuration information for a particular area of receiver operation. Application files can include the following records:

- File Storage
- General Controls
- Serial Port Baud/Format
- Reference Position
- Logging Rate
- SV Enable/Disable
- Output Message
- Antenna
- Device Control
- Static/Kinematic
- Input Message

An application file does not have to contain all of these records. When you apply an application file, any option that is not included in the records in the file remains at its current setting. For example, if you apply an application file that only specifies the elevation mask to use, all other settings remain as they were before the application file was applied.

You can store up to ten different application files in the receiver. You can apply an application file's settings at the time it is transferred to the receiver, or at any time afterwards.

Special application files

The receiver has three special application files, which control important aspects of the receiver's configuration.

Default application file

The default application file (Default.cfg) contains the original receiver configuration, and cannot be changed. This file configures the receiver after it is reset. You can reset the receiver by holding down **[P]** for at least 15 seconds, or by using the reset option in the GPS Configurator software.

For more information, see [Default settings, page 54](#).

Although you cannot change or delete the default application file, you can use a power up application file to override any or all of the default settings.

Current application file

The current application file (Current.cfg) reflects the current receiver configuration. Whenever you change the receiver's configuration, either in real time or by applying an application file, the current file changes to match the new configuration.

You cannot delete the current file or change it directly, but every change to the receiver's current configuration is applied to the current file as well.

When you switch off the receiver then turn it on again, all the settings from the current application file are applied, so you do not lose any changes that you have made. The only exceptions are the following logging parameters:

- Logging rate
- Position rate
- Elevation mask

These parameters are always reset to the factory default values whenever the receiver is switched off.

Power up application file

The power up application file (Power_up.cfg) is used to set the receiver to a specific configuration any time the unit is turned on.

In this file, you can specify that the receiver is reset to defaults before the power up settings are applied. This ensures that restarting the receiver always results in the same configuration. This method is useful for defining “default” settings for the receiver that differ from those in the default file, which cannot be changed.

Alternatively, you can specify that the power up settings are applied immediately after the current application file’s settings have been applied. Restarting the receiver results in a configuration that uses your default settings for the options you define in the power up file, but the current settings for all other options.

By default, there is no power_up application file on the receiver. To use a power up application file, you must create and save a power_up application file in the GPS Configurator software. If you save this file to disk, the file is called power_up.cfg. The extension .cfg is used, by convention, to identify application files on the office computer. When you transfer this file to the receiver, the file is saved on the receiver as power_up, and becomes the new power up file.

Applying application files

An application file’s settings do not affect the receiver’s configuration until you **apply** the application file. You can do this at the same time that you save the file.

Alternatively, you can save the file on the computer or in the receiver, then open it later and apply its settings.

Storing application files

You can store application files that you create in the GPS Configurator software on the receiver and on the computer. For example, each file can represent a different user sharing the same receiver, or a particular mode of operation or survey style. Saving application files on your computer as well as in your receiver is optional, but it is useful because:

- it gives you a permanent copy of the settings you have sent to a receiver, for audit or your own reference.
- you can use the same file to configure multiple receivers identically.
- you can use an existing application file as a template to create other application files with similar settings.

Naming application files

The application filename in the office computer and in the receiver are always the same. This makes it easier to recognize and keep track of your application files.

When you change the name of the application file in the receiver, this changes the application filename on your computer. When you transfer an application file from the receiver and save it to the computer, the system renames the file to match the internal receiver file. However, if you use Windows Explorer, for example, to change the .cfg filename on the computer, this **does not** change the internal receiver filename. This means that the GPS receiver does not recognize the change to the filename on the computer.

Software Utilities

This chapter describes the software utilities that you can use with the receiver.

In this chapter:

- The GPS Configurator software
- The WinFlash Utility

The GPS Configurator software

GPS Configurator is office software that configures selected Trimble GPS or GNSS receivers.

GPS Configurator software enables you to:

- edit and save configuration files to the receiver and the computer
- check current receiver settings and operation
- configure receiver settings with your office computer

Installing the GPS Configurator software

A copy of GPS Configurator software is included on the receiver CD.

1. Insert the CD into the CD drive on your computer.
2. From the main menu, select *Install individual software packages*.
3. Select *Install GPS Configurator vX.XX*.
4. Follow the onscreen instructions.

Configuring the receiver using GPS Configurator software

1. Connect Port 1 or 2 on the receiver to a serial (COM) port on the computer and apply power.
2. To start GPS Configurator, click  and then select *Programs / Trimble / GPS Configurator / GPS Configurator*.
3. In the *Device Type* dialog, select *Trimble R8/R6*.
The software automatically establishes a connection with the receiver.
4. Make appropriate selections for your required receiver settings.
For more information, refer to the *GPS Configurator Help*.
5. Click **Apply**.

The settings in GPS Configurator software are applied to the receiver.

The WinFlash Utility

The WinFlash utility communicates with Trimble products to perform various functions including:

- installing software, firmware, and option upgrades
- running diagnostics (for example, retrieving configuration information)
- configuring radios

For more information, online help is also available when using the WinFlash utility.

Note – *The WinFlash utility runs on Windows 2000, XP, or Windows Vista® operating systems.*

Installing the WinFlash utility

1. Insert the receiver CD into the CD drive on the computer.
2. From the main menu, select *Install individual software packages*.
3. Select *Install WinFlash vX.XX for R/5000/NetR5 receivers* and then follow the on-screen instructions.

Alternatively, install the WinFlash utility from the Trimble website

Upgrading firmware

Your receiver is supplied with the latest version of receiver firmware installed. If a later version becomes available, upgrade the firmware installed on your receiver.

The WinFlash utility guides you through the firmware upgrade process. The steps required are described below. For more information, refer to the *WinFlash Help*.

To upgrade the receiver firmware:

1. Start the WinFlash utility. The *Device Configuration* screen appears.
2. From the *Device type* list, select *Trimble R8/R6*.
3. From the *PC serial port* field, select the serial (COM) port on the computer that the receiver is connected to.

4. Click **Next**.

The *Operation Selection* screen appears. The *Operations* list shows all of the supported operations for the selected device. A description of the selected operation is shown in the *Description* field.

5. Select GPS software upgrade and click **Next**.

The *GPS Software Selection* window appears. This screen prompts you to select the software that you want to install on the receiver.

6. Select the latest version from the *Available Software* list and then click **Next**.

The *Settings Review* window appears. This screen prompts you to connect the receiver, suggests a connection method and then lists the receiver configuration and selected operation.

7. If all is correct, click **Finish**.

Based on your selections, the *Software Upgrade* window appears and shows the status of the operation (for example, **Establishing communication with the 5800. Please wait ...**)

8. Click **OK**.

The *Software Upgrade* window appears again and states that the operation was completed successfully.

9. Click **Menu** to select another operation, or click **Exit** to quit WinFlash.

10. If you click **Exit**, another screen appears asking you to confirm that you want to quit. Click **OK**.

Adding frequencies for the 450 MHz internal radio

If your receiver has the optional internal radio installed, you can use the WinFlash utility to add receiving frequencies to the default list. If you purchase a transmit upgrade (after initial purchase), the broadcast frequencies must be programmed using a .set file obtained from a Trimble service provider.

1. Start the WinFlash utility. The *Device Configuration* screen appears.
2. From the *Device type* list, select the appropriate receiver name.
3. From the *PC serial port* field, select the serial (COM) port on the computer that the receiver is connected to.
4. Click **Next**.

The *Operation Selection* screen appears. The *Operations* list shows all of the supported operations for the selected device. A description of the selected operation is shown in the *Description* field.

5. Select *Configure Radio* and then click **Next**.

The *Frequency Selection* dialog appears:

Frequency Selection

You have connected to a Trimble R8 Internal

Frequency Band: 410.0 - 430.0 MHz

Wireless Format

Current Channel: 1 - 419.550 MHz

Wireless Mode: TRIMTALK 450S at 9600 bps

Note: Wireless mode must be common among all radios in your network.

Channel Frequency

Specify Frequency:

419.5500 MHz Add

Selected Frequencies:

Channel	Frequency
1	419.5500
2	420.0000
3	430.0000

Remove
Remove All
Move Up
Move Down

OK
Cancel
Radio Info...
Save...
Print

6. In the *Wireless Format* group, select the appropriate channel and wireless mode. The Wireless Mode must be the same for all radios in your network.
7. In the *Specify Frequency* field, enter the frequency you require.
8. Click **Add**. The new frequency appears in the *Selected Frequencies* list.

Note – The frequencies that you program must conform to the channel spacing and minimum tuning requirements for the radio. To view this information, click **Radio Info**. You may select either 12.5 or 25 kHz channel spacing. All radios in your network must use the same channel spacing.

9. When you have configured all the frequencies you require, click **OK**.
The WinFlash utility updates the receiver radio frequencies and then restarts the receiver.

Note – You can only configure receive frequencies. The FCC approved transmit frequencies must be specified and configured by Trimble.

Configuring the internal transceiver

Use the WinFlash *Internal Transceiver Configuration* dialog to configure the internal transceiver.



Tip – To view a list of all radio information, including the current configuration, click **Radio Info**.

1. Select the *Current Channel*, which determines the radio operating frequency.
2. Select the *Wireless Mode*, which determines the over-the-air communications parameters. The following example shows a rover setup:

Internal Transceiver Configuration

You have connected to a Trimble R8 Internal Radio

Wireless Format

Current Channel: Ch. 1 - 461.0250 MHz

Wireless Mode: TRIMTALK 450S at 4800 bps

Note: Wireless mode must be common among all radios in your network.

Radio Settings

Mode: Rover

Channel Frequency

Specify Frequency: 461.02500 MHz

Add

Selected Frequencies:

Channel	Frequency
1	461.02500
2	461.07500
3	461.10000
4	462.12500
5	462.37500
6	462.40000
7	464.50000
8	464.55000
9	464.60000
10	464.62500

Remove
Remove All
Move Up
Move Down

To reduce battery consumption on your base receiver, set the wireless mode as high as possible. For example, 9600 bits per second (bps) consumes half the power of 4800 bps for the same data format and time of operation.

Note – All radios in the network must be configured with the same wireless setting.

3. Select the appropriate operating mode, depending on how you intend to use the receiver, for example, *Base with No Repeaters*:

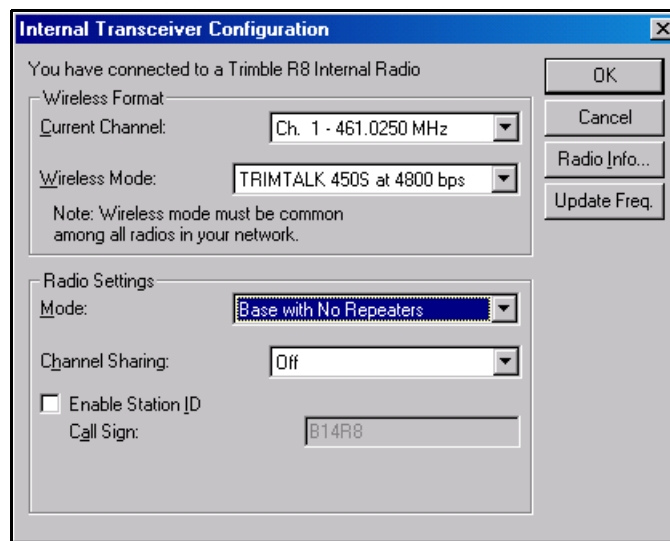

4. Select one of the following channel sharing configurations (base modes only; not available for rover):
 - Off. The carrier detect mode is off. The unit will ignore other transmissions on your frequency and continue to transmit data.

Note – It may be illegal in your country of use to set channel sharing to Off. You may be subject to penalties or fines based upon the specific licensing requirements for your country of use. Please consult your radio license documentation or licensing agency for operational guidelines.
 - Avoid Weak Signals. The carrier detect mode is on. The radio will cease transmitting if it detects another radio transmission on its frequency. It will resume transmission when the channel is free of radio traffic.
 - Avoid Strong Signals. The carrier detect mode is on, but the radio will stop transmitting only when there is a strong signal present (receive level greater than 90 dBm).
5. If you are operating in Base mode, select the *Enable Station ID* check box and then enter your call sign in the *Call Sign* field. This FCC requirement is for U.S. licensed users. It sets your radio to transmit your call sign in Morse code every 15 minutes.
6. To update the configuration, click **OK**.

In the *Status* dialog that appears, select an option to return to the main menu or to exit the WinFlash utility.



Tip – You can print or save the radio configuration information for future reference. If required, you can fax or e-mail the file to Trimble Support to aid in troubleshooting radio problems.

Updating the frequency list

You can program the internal transceiver modem with a list of up to 20 frequencies, which are stored in non-volatile memory. This list is pre-configured based on the frequencies that you requested when you ordered the unit. Government regulations stipulate that only manufacturers or authorized dealers can create this frequency list and that all frequencies programmed into a unit must comply with the host country regulations. If you need to add, delete, or replace frequencies, contact your Trimble dealer, and provide the radio modem serial number and an updated list of the frequencies you require. Once you receive the frequency file, you can upgrade the radio using the WinFlash utility.

Specifications

In this chapter:

- Physical specifications
- Positioning specifications
- Technical specifications

This chapter lists the receiver specifications. Where specifications apply to only one receiver model, this is clearly indicated.

For more detailed specifications, refer to the appropriate receiver data sheets that are available on www.trimble.com.

Physical specifications

Feature	Specification
Size	19.0 cm (7.5") wide x 11.2 cm (4.4") deep including connectors
Weight: with internal battery, radio, and standard antenna	1.34 kg (2.95 lbs)
Operating times on internal 2.4 Ah battery (varies with temperature)	450 MHz receive only - 5.8 hours 450 MHz receive/transmit: 3.7 hours (varies with wireless data rate) GSM: 4.1 hours
Power input	11–28 V DC with over-voltage protection on port 1 (7-pin lemo)
Operating temperature ^a	–40 °C to +65 °C (–40 °F to +149 °F)
Storage temperature	–40 °C to +75 °C (–40 °F to +167 °F)
Humidity	100% condensing, unit fully sealed
Casing	Water/dustproof IP67 dustproof, protected from temporary immersion to depth of 1 m (3.28 ft)

^aReceiver will operate normally to –40 °C.
Internal batteries are rated to –20 °C.
GSM module is rated to –30°C.

Positioning specifications

Feature	Specification
Code differential GPS positioning^a	
Horizontal	±0.25 m + 1ppm RMS
Vertical	±0.50 m + 1ppm RMS
WAAS differential positioning accuracy ^b	typically <5 m 3DRMS
Static and FastStatic GPS surveying^a	
Horizontal	±5 mm + 0.5 ppm RMS
Vertical	±5 mm + 1 ppm RMS
Kinematic surveying^a	
Horizontal	±10 mm + 1 ppm RMS
Vertical	±20 mm + 1 ppm RMS

^a Accuracy and reliability may be subject to anomalies due to multipath, obstructions, satellite geometry, and atmospheric conditions. Always follow recommended survey practices.

^b Depends on WAAS/EGNOS system performance.

Technical specifications

Feature	Specification
Tracking:	
Trimble R8 GNSS receiver	<p>Possible number of satellites simultaneously tracked^a</p> <ul style="list-style-type: none"> GPS + GLONASS 26 total Galileo GIOVE-A & GIOVE-B SBAS 4 <p>Signals tracked simultaneously</p> <ul style="list-style-type: none"> GPS L1C/A, L1C, L1E, L2C, L2E, L5 GLONASS L1C/A, L1P, L2C/A (GLONASS M only), L2P SBAS L1C/A, L5 <p>Fully operational during P-code encryption</p>
Trimble R6 GPS receiver	<p>72 Channels GPS L1 C/A Code, L1/L2 Full Cycle Carrier, (Optional) GLONASS L1 C/A Code, L1 P Code, L2 P Code, L1/L2 Full Cycle Carrier</p> <p>4 additional channels for SBAS WAAS/EGNOS support</p> <p>Fully operational during P-code encryption</p>
5800 GPS receiver	<p>24 Channels GPS L1 C/A Code, L1/L2 Full Cycle Carrier</p> <p>2 additional channels for SBAS WAAS/EGNOS support</p> <p>Fully operational during P-code encryption</p>
Signal processing	<p>Advanced Trimble Maxwell™ Custom Survey GNSS chip</p> <p>Very low-noise GNSS carrier phase measurements with <1 mm precision in a 1 Hz bandwidth</p> <p>Multipath suppression</p>
Start-up	<p>Cold start: < 60 seconds from power on</p> <p>Warm start: < 30 seconds with recent ephemeris</p>
Initialization	Automatic while moving or static
Initialization time ^b	<p>Typically:</p> <ul style="list-style-type: none"> <10 seconds (Trimble R8 GNSS) <20 seconds (Trimble R6 & 5800)
Initialization reliability ^c	Typically >99.9%
Communications	<p>Two RS-232 serial ports (Port 1, Port 2,)</p> <p>Baud Rates up to 115,200 bps</p> <p>RTS/CTS flow control negotiation supported on port 2</p> <p>Bluetooth communications through Trimble controller with Bluetooth support</p>
Configuration	Through user-definable application files or GPS Configurator
Output formats	<p>NMEA-0183: AVR; GGA; GSA; GST; GSV; PTNL,GGK; PTNL,GGK_SYNC; HDT; PTNL,PJK; PTNL,PJT; RMC, ROT; PTNL,VGK; VHD; VTG; ZDA</p> <p>GSOE (Trimble Binary Streamed Output)</p> <p>RT17</p>

^a Up to 220 channels available, based on installed options.

^b May be affected by atmospheric conditions, signal multipath, obstructions and satellite geometry.

^c May be affected by atmospheric conditions, signal multipath, and satellite geometry. Initialization reliability is continuously monitored to ensure highest quality.

Default Settings

In this chapter:

- [Default settings](#)
- [Resetting to factory defaults](#)

All receiver settings are stored in application files. The default application file, `Default.cfg`, is stored permanently in the receiver, and contains the factory default settings for the receiver.

Whenever the receiver is reset to its factory defaults, the current settings (stored in the current application file, `current.cfg`) are reset to the values in the default application file.

You cannot modify the default application file. However, if there is a power up application file (`Power_up.cfg`) in the receiver, the settings in this file can be applied immediately after the default application file, overriding the factory defaults.

For more information, see [Application files](#), page 36.

Default settings

These settings are defined in the default application file.

Table 8.1 Default settings

Function		Factory default
SV Enable		All SVs enabled
General Controls:	Elevation mask	13°
	PDOP mask	7
	RTK positioning mode	Low Latency
	Motion	Kinematic
Serial Port 1:	Baud rate	38400
	Format	8-None-1
	Flow control	None
Serial Port 2:	Baud rate	38400
	Format	8-None-1
	Flow control	None
Input Setup:	Station	Any
NMEA/ASCII (all supported messages)		All ports Off
Streamed output		All Types Off Offset = 00
RT17/Binary		All ports Off
Reference position:	Latitude	0°
	Longitude	0°
	Altitude	0.00 m HAE
Antenna:	Type	Trimble R6 Internal /Trimble R8 Model 2 internal/5800 internal
	Height (true vertical)	0.00 m
	Group	All
	Measurement method	Bottom of mount

Resetting to factory defaults

To reset the receiver to its factory defaults, do one of the following:

- On the receiver, press and hold down the Power button for 15 seconds.
- In the GPS Configurator software, select *Connect to Receiver* and then click **Reset receiver** in the *General* tab.

Default behavior

The factory defaults specified above are applied whenever you start the receiver. If a power up file is present in the receiver, its settings are applied immediately after the default settings, so you can use a power up file to define your own set of defaults.

When you turn the receiver on and ...	then logging settings are ...	and logging ...
it is the first time that the receiver has been used	the factory defaults	does not begin automatically
you have reset the receiver to its factory defaults	the factory defaults, or those in the power up file ^a	does not begin automatically
you have performed a full reset	the factory defaults, because resetting deletes any power up file	does not begin automatically

^aA factory default setting is used only if the setting is not defined in the power up file.

Power up settings

When you turn off the receiver, any changes that you have made to logging settings are lost and these settings are returned to the factory defaults. Other settings remain as defined in the current file. The next time you turn on the receiver, the receiver checks for a power up file and, if one is present, applies the settings in this file.

When you use the Power button to turn off and then turn on the receiver and ...	then logging settings are ...	and all other settings are ...
you changed the receiver settings by applying an application file	the factory defaults	the last settings used
you changed the receiver settings using configuration software	the factory defaults	the last settings used
there is a power up application file in the receiver	the factory defaults, or those in the power up file ^a	the last settings used, or those in the power up file

^aA factory default setting is used only if the setting is not defined in the power up file.

Cables and Connectors

In this chapter:

- Port 1 and 2 connectors
- Power/serial data cables

This chapter describes the pinouts for the receiver standard and optional cables. This information can be used to prepare special cables for connecting the receiver to devices and instruments not supported by the standard and optional cables.

Port 1 and 2 connectors

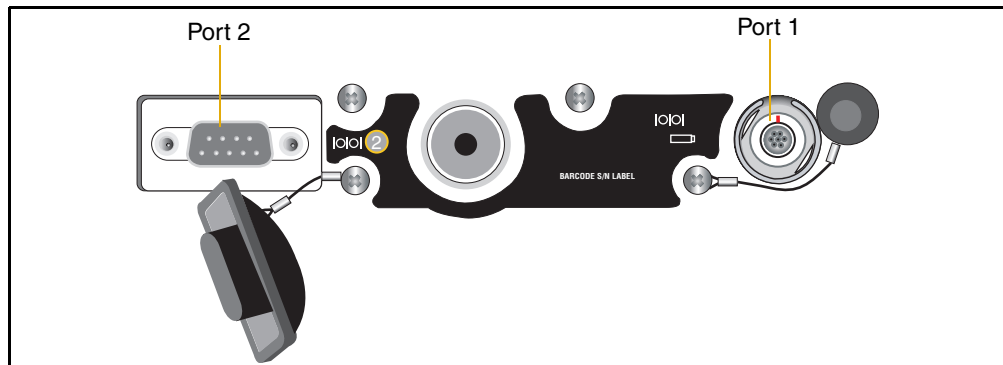

Figure 9.1 Receiver serial ports

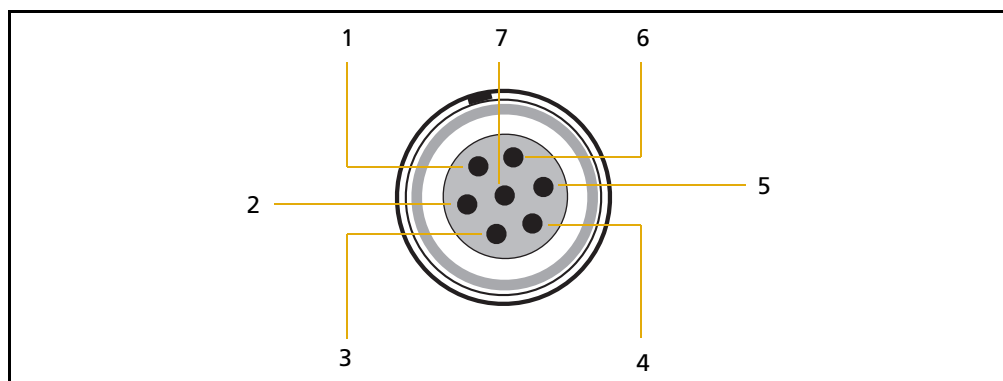

Figure 9.2 Port 1 connector pinouts

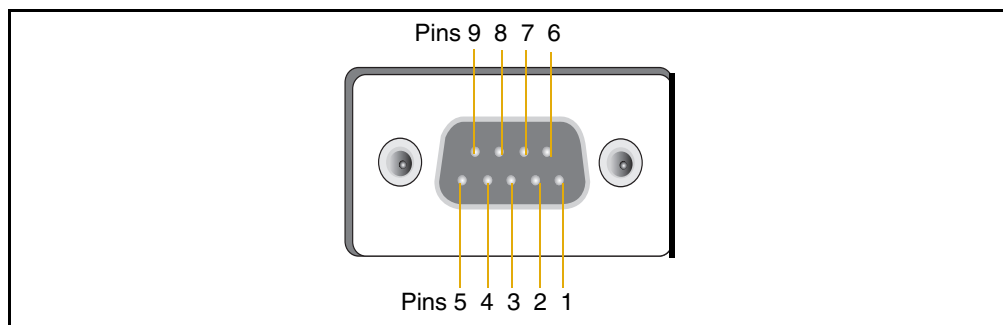

Figure 9.3 Port 2 connector pinouts

Pin	Pinout function	
	Port 1 – 7-pin Lemo	Port 2 – DB-9
1	Signal ground	DCD
2	Power ground	RXD
3	TXD	TXD
4	N/C	DTR
5	N/C	Signal ground
6	+ Power in	DSR

Pin	Pinout function	
	Port 1 – 7-pin Lemo	Port 2 – DB-9
7	TRXD	RTS
8	N/A	CTS
9	N/A	Ring indicator

Power/serial data cables

The data-I/O cable is supplied with the receiver.

Table 9.1 Data-I/O cable pinouts

DB-9 Female 9-pin		DB-9 Female 9-pin	
Pin	Function	Pin	Function
1-6	DCD5_232	4	DTR5_232
2	RX5_232	3	TX5_232
3	TX5_232	2	RX5_232
4	DTR5_232	1-6	DCD5_232
5	GND	5	GND
7	RTS5_232	8	CTS5_232
8	CTS5_232	7	RTS5_232
9	no connection RI5_232	9	

Note – Table 9.1 assumes that the cable is attached to the connector labeled Port 2.

This data cable may be used for firmware upgrades and other computer functions with the receiver. Power must be supplied to the receiver through Port 1, or from the internal battery.

Note – This pinout information also applies to the power/serial data cable, which is optional for use with the receiver. This cable can be used for firmware upgrades through Port 1, while also supplying external power.

Note – Table 9.2 assumes that the cable is attached to the connector labeled Port 1.

Table 9.2 Power/serial data cable pinouts

Lemo 0-shell connector 7-Pin		Direction	DE9-F connector 7 Cond			Power lead 2 Cond	
Pin	Function		Pin	Color	Function	Color	Function
1	GND	↔	5	Brown	Signal ground		
2	GND	→				Black	V-OUT
3	TX3_232	→	2	Orange	TXD		
4	RTS/TXD	→	8	Blue	RTS		
5	CTS/RXD	←	7	Green	CTS		

Table 9.2 Power/serial data cable pinouts (continued)

Lemo 0-shell connector 7-Pin		Direction	DE9-F connector 7 Cond			Power lead 2 Cond	
Pin	Function		Pin	Color	Function	Color	Function
6	PWR_IN	←				Red	Power IN (+)
7	RX3_232	←	3	Yellow	TXD		

A

NMEA-0183 Output

In this appendix:

- [NMEA-0183 Outputs](#)
- [Common Message Elements](#)
- [NMEA Messages](#)

This appendix describes the formats of the subset of NMEA-0183 messages that are available for output by the receiver. For a copy of the NMEA-0183 Standard, go to the National Marine Electronics Association website at www.nmea.org.

NMEA-0183 Outputs

When NMEA-0183 output is enabled, a subset of NMEA-0183 messages can be output to external instruments and equipment connected to the Trimble receiver serial ports. These NMEA-0183 messages let external devices use selected data collected or computed by the receiver.

All messages conform to the NMEA-0183 version 3.01 format. All begin with \$ and end with a carriage return and a line feed. Data fields follow comma (,) delimiters and are variable in length. Null fields still follow comma (,) delimiters but contain no information.

An asterisk (*) delimiter and checksum value follow the last field of data contained in an NMEA-0183 message. The checksum is the 8-bit exclusive *OR* of all characters in the message, including the commas between fields, but not including the \$ and asterisk delimiters. The hexadecimal result is converted to two ASCII characters (0–9, A–F). The most significant character appears first.

The following table summarizes the set of NMEA messages supported by the receiver, and shows the page where detailed information about each message can be found.

Message	Function	Page
AVR	Time, yaw, tilt, range, mode, PDOP, and number of SVs for Moving Baseline RTK	64
GGA	Time, position, and fix related data	64
GSA	GNSS DOP and active satellites	65
GST	Position error statistics	66
GSV	Number of SVs in view, PRN, elevation, azimuth, and SNR	66
HDT	Heading from True North	67
PTNL,GGK	Time, position, position type and DOP values	67
PTNL,GGK_SYNC	Time, synchronized position, position type and DOP values	68
PTNL,PJK	Local coordinate position output	69
PTNL,PJT	Projection type	69
PTNL,VGK	Time, locator vector, type and DOP values	70
PTNL,VHD	Heading Information	70
RMC	Position, Velocity, and Time	71
ROT	Rate of turn	71
VTG	Actual track made good and speed over ground	72
ZDA	UTC day, month, and year, and local time zone offset	72

To enable or disable the output of individual NMEA messages, do one of the following:

- Create an application file in the GPS Configurator software that contains NMEA output settings and then send the file to the receiver.
- Add NMEA outputs in the *Serial outputs* tab of the GPS Configurator software and then apply the settings.

Common Message Elements

Each message contains:

- A message ID consisting of *\$GP* followed by the message type. For example, the message ID of the GGA message is *\$GPGGA*.
- A comma
- A number of fields, depending on the message type, separated by commas
- An asterisk
- A checksum value

Below is an example of a simple message with a message ID (*\$GPGGA*), followed by 13 fields and a checksum value:

```
$GPGGA,172814.0,3723.46587704,N,12202.26957864,W,2,6,1.2,18.893,M,-  
25.669,M,2.0,0031*4F
```

Message values

The following values can be found in NMEA messages that the receiver generates.

Latitude and longitude

Latitude is represented as *ddmm.mmmm* and longitude is represented as *dddmm.mmmm*, where:

- *dd* or *ddd* is degrees
- *mm.mmmm* is minutes and decimal fractions of minutes

Direction

Direction (north, south, east, or west) is represented by a single character: *N*, *S*, *E*, or *W*.

Time

Time values are presented in Universal Time Coordinated (UTC) and are represented as *hhmmss.cc*, where:

- *hh* is hours, from 00 to 23
- *mm* is minutes
- *ss* is seconds
- *cc* is hundredths of seconds

NMEA Messages

When NMEA-0183 output is enabled, the following messages can be generated.

AVR Time, Yaw, Tilt, Range for Moving Baseline RTK

The AVR message string is shown below, and [Table A.1](#) describes the message fields.

```
$PTNL,AVR,181059.6,+149.4688,Yaw,+0.0134,Tilt,,,60.191,3,2.5,6*00
```

Table A.1 AVR message fields

Field	Meaning
1	UTC of vector fix
2	Yaw angle in degrees
3	Yaw
4	Tilt angle in degrees
5	Tilt
6	Reserved
7	Reserved
8	Range in meters
9	Quality indicator: 0: Fix not available or invalid 1: Autonomous GPS fix 2: Differential carrier phase solution RTK (Float) 3: Differential carrier phase solution RTK (Fix) 4: Differential code-based solution, DGPS
10	PDOP
11	Number of satellites used in solution

GGA Time, Position, and Fix Related Data

An example of the GGA message string is shown below. [Table A.2](#) describes the message fields.

```
$GPGGA,172814.0,3723.46587704,N,12202.26957864,W,  
2,6,1.2,18.893,M,-25.669,M,2.0,0031*4F
```

Table A.2 GGA message fields

Field	Meaning
1	UTC of position fix
2	Latitude
3	Direction of latitude: N: North S: South
4	Longitude
5	Direction of longitude: E: East W: West

Table A.2 GGA message fields (continued)

Field	Meaning
6	GPS Quality indicator: 0: Fix not valid 1: GPS fix 2: Differential GPS fix 4: Real Time Kinematic, fixed integers 5: Real Time Kinematic, float integers
7	Number of SVs in use, range from 00 to 12
8	HDOP
9	Orthometric height (MSL reference)
10	M: unit of measure for height is meters
11	Geoid separation
12	M: geoid separation is measured in meters
13	Age of differential GPS data record, Type 1 or Type 9. Null field when DGPS is not used.
14	Reference station ID, ranging from 0000 to 1023. A null field when any reference station ID is selected and no corrections are received.

GSA GNSS DOP and active satellites

An example of the GSA message string is shown below. [Table A.3](#) describes the message fields.

```
$GPGSA,<1>,<2>,<3>,<3>,,,,,<3>,<3>,<3>,<4>,<5>,  
<6>*<7><CR><LF>
```

Table A.3 GSA message fields

Field	Meaning
1	Mode 1, M = manual, A = automatic
2	Mode 2, Fix type, 1 = not available, 2 = 2D, 3 = 3D
3	PRN number, 01 to 32, of satellite used in solution, up to 12 transmitted
4	PDOP-Position dilution of precision, 0.5 to 99.9
5	HDOP-Horizontal dilution of precision, 0.5 to 99.9
6	VDOP-Vertical dilution of precision, 0.5 to 99.9
7	Checksum

GST Position Error Statistics

An example of the GST message string is shown below. [Table A.4](#) describes the message fields.

```
$GPGST,172814.0,0.006,0.023,0.020,273.6,
0.023,0.020,0.031*6A
```

Table A.4 GST message fields

Field	Meaning
1	UTC of position fix
2	RMS value of the pseudorange residuals (includes carrier phase residuals during periods of RTK(float) and RTK(fixed) processing)
3	Error ellipse semi-major axis 1 sigma error, in meters
4	Error ellipse semi-minor axis 1 sigma error, in meters
5	Error ellipse orientation, degrees from true north
6	Latitude 1 sigma error, in meters
7	Longitude 1 sigma error, in meters
8	Height 1 sigma error, in meters

GSV Satellite Information

The GSV message string identifies the number of SVs in view, the PRN numbers, elevations, azimuths, and SNR values. An example of the GSV message string is shown below. [Table A.5](#) describes the message fields.

```
$GPGSV,4,1,13,02,02,213,,03,-3,000,,
11,00,121,,14,13,172,05*67
```

Table A.5 GSV message fields

Field	Meaning
1	Total number of messages of this type in this cycle
2	Message number
3	Total number of SVs visible
4	SV PRN number
5	Elevation, in degrees, 90° maximum
6	Azimuth, degrees from True North, 000° to 359°
7	SNR, 00–99 dB (null when not tracking)
8–11	Information about second SV, same format as fields 4–7
12–15	Information about third SV, same format as fields 4–7
16–19	Information about fourth SV, same format as fields 4–7

HDT Heading from True North

The HDT string is shown below, and [Table A.6](#) describes the message fields.

```
$GPHDT,123.456,T*00
```

Table A.6 Heading from true north fields

Field	Meaning
1	Heading in degrees
2	T: Indicates heading relative to True North

PTNL,GGK Time, Position, Position Type, DOP

An example of the PTNL,GGK message string is shown below. [Table A.7](#) describes the message fields.

```
$PTNL,GGK,172814.00,071296,  
3723.46587704,N,12202.26957864,W,  
3,06,1.7,EHT-6.777,M*48
```

Table A.7 PTNL,GGK message fields

Field	Meaning
1	UTC of position fix
2	Date
3	Latitude
4	Direction of latitude: N: North S: South
5	Longitude
6	Direction of Longitude: E: East W: West
7	GPS Quality indicator: 0: Fix not available or invalid 1: Autonomous GPS fix 2: Differential, floating carrier phase integer-based solution, RTK(float) 3: Differential, fixed carrier phase integer-based solution, RTK(fixed) 4: Differential, code phase only solution (DGPS)
8	Number of satellites in fix
9	DOP of fix
10	Ellipsoidal height of fix
11	M: ellipsoidal height is measured in meters

Note – The PTNL,GGK message is longer than the NMEA-0183 standard of 80 characters.

PTNL,GGK_SYNC

Time, Synchronized Position, Position Type, DOP

The PTNL,GGK_SYNC message has the same format as the PTNL,GGK message, but outputs Synchronized 1 Hz positions even in Low Latency mode. An example of the PTNL,GGK_SYNC message string is shown below. [Table A.8](#) describes the message fields.

```
$PTNL,GGK_SYNC,172814.00,071296,
3723.46587704,N,12202.26957864,W,
3,06,1.7,EHT-6.777,M*48
```

Table A.8 PTNL,GGK_SYNC message fields

Field	Meaning
1	UTC of position fix
2	Date
3	Latitude
4	Direction of latitude: N: North S: South
5	Longitude
6	Direction of Longitude: E: East W: West
7	GPS Quality indicator: 0: Fix not available or invalid 1: Autonomous GPS fix 2: Differential, floating carrier phase integer-based solution, RTK(float) 3: Differential, fixed carrier phase integer-based solution, RTK(fixed) 4: Differential, code phase only solution (DGPS)
8	Number of satellites in fix
9	DOP of fix
10	Ellipsoidal height of fix
11	M: ellipsoidal height is measured in meters

Note – The PTNL,GGK_SYNC message is longer than the NMEA-0183 standard of 80 characters.

PTNL,PJK Local Coordinate Position Output

An example of the PTNL,PJK message string is shown below. [Table A.9](#) describes the message fields.

```
$PTNL,PJK,010717.00,081796,
+732646.511,N,+1731051.091,E,
1,05,2.7,EHT-28.345,M*7C
```

Table A.9 PTNL,PJK message fields

Field	Meaning
1	UTC of position fix
2	Date
3	Northing, in meters
4	Direction of Northing will always be N (North)
5	Easting, in meters
6	Direction of Easting will always be E (East)
7	GPS Quality indicator: 0: Fix not available or invalid 1: Autonomous GPS fix 2: Differential, floating carrier phase integer-based solution, RTK (float) 3: Differential, fixed carrier integer-based solution, RTK (fixed) 4: Differential, code phase only solution (DGPS)
8	Number of satellites in fix
9	DOP of fix
10	Ellipsoidal height of fix
11	M: ellipsoidal height is measured in meters

Note – The PTNL,PJK message is longer than the NMEA-0183 standard of 80 characters.

PTNL,PJT Projection Type

An example of the PTNL,PJT message string is shown below. [Table A.10](#) describes the message fields.

```
$PTNL,PJT,NAD83(Conus),California Zone 4 0404,*51
```

Table A.10 PTNL,PJT message fields

Field	Meaning
1	Coordinate system name (can include multiple words)
2	Projection name (can include multiple coordinates)

PTNL,VGK

Vector Information

An example of the PTNL,VGK message string is shown below. [Table A.11](#) describes the message fields.

```
$PTNL,VGK,160159.00,010997,-0000.161,
00009.985,-0000.002,3,07,1,4,M*0B
```

Table A.11 PTNL,VGK message fields

Field	Meaning
1	UTC of vector in hhmmss.ss format
2	Date in mmddyy format
3	East component of vector, in meters
4	North component of vector, in meters
5	Up component of vector, in meters
6	GPS quality indicator: 0: Fix not available or invalid 1: Autonomous GPS fix 2: Differential carrier phase solution RTK(float) 3: Differential carrier phase solution RTK(fix) 4: Differential code-based solution, DGPS
7	Number of satellites if fix solution
8	DOP of fix
9	M: Vector components are in meters

PTNL,VHD

Heading Information

An example of the PTNL,VHD message string is shown below. [Table A.12](#) describes the message fields.

```
$PTNL,VHD,030556.00,093098,187.718,
-22.138,-76.929,-5.015,0.033,0.006,
3,07,2,4,M*22
```

Table A.12 PTNL,VHD message fields

Field	Meaning
1	UTC of position, in <i>hhmmss.ss,ddmmyy</i> format
2	Date in mmddyy format
3	Azimuth
4	Δ Azimuth/ Δ Time
5	Vertical Angle
6	Δ Vertical/ Δ Time
7	Range
8	Δ Range/ Δ Time

Table A.12 PTNL,VHD message fields (continued)

Field	Meaning
9	Quality indicator: 0: Fix not available or invalid 1: Autonomous GPS fix 2: Differential carrier phase solution RTK(float) 3: Differential carrier phase solution RTK(fix) 4: Differential code-based solution, DGPS
10	Number of satellites used in solution
11	PDOP

RMC **Position, Velocity, and Time**

The RMC string is shown below, and [Table A.13](#) describes the message fields.

```
$GPRMC,123519,A,4807.038,N,01131.000,E,022.4,084.4,230394,003.1,W*6A
```

Table A.13 GPRMC message fields

Field	Meaning
1	UTC of position fix
2	Status A=active or V=void
3	Latitude
4	Longitude
5	Speed over the ground in knots
6	Track angle in degrees (True)
7	Date
8	Magnetic variation
9	The checksum data, always begins with *

ROT **Rate of Turn**

The ROT string is shown below, and [Table A.14](#) describes the message fields.

```
$GPROT,35.6,A*4E
```

Table A.14 ROT message fields

Field	Meaning
1	Rate of turn, degrees/minutes, "-" indicates bow turns to port
2	A: Valid data V: Invalid data

VTG Actual Track Made Good Over and Speed Over Ground

An example of the VTG message string is shown below. [Table A.15](#) describes the message fields.

```
$GPVTG,,T,,M,0.00,N,0.00,K*4E
```

Table A.15 VTG message fields

Field	Meaning
1	Track made good (degrees true)
2	T: track made good is relative to true north
3	Track made good (degrees magnetic)
4	M: track made good is relative to magnetic north
5	Speed, in knots
6	N: speed is measured in knots
7	Speed over ground in kilometers/hour (kph)
8	K: speed over ground is measured in kph

ZDA UTC Day, Month, And Year, and Local Time Zone Offset

An example of the ZDA message string is shown below. [Table A.16](#) describes the message fields.

```
$GPZDA,172809,12,07,1996,00,00*45
```

Table A.16 ZDA message fields

Field	Meaning
1	UTC
2	Day, ranging between 01 and 31
3	Month, ranging between 01 and 12
4	Year
5	Local time zone offset from GMT, ranging from 00 to ± 13 hours
6	Local time zone offset from GMT, ranging from 00 to 59 minutes

Fields 5 and 6 together yield the total offset. For example, if field 5 is -5 and field 6 is $+15$, local time is 5 hours and 15 minutes earlier than GMT.

RTCM Output

In this appendix:

- [Generated messages](#)
- [Message scheduling](#)

Generated messages

Table B.1 shows the messages that are generated when you select a specific RTCM version. The messages in the table are in the same order as they appear in the GPS Configurator software. For the details of the contents of individual messages, refer to the RTCM documentation.

Table B.1 RTCM output

Selection	Message								
Version 2	1	3			22				59
USCG 9-3		3	9-3						
RTCM/RTK 2.2+2.3	1	3		18	19	22	23	24	59
RTK Only 2.2+2.3		3		18	19	22	23	24	59
RTCM/RTK 2.3	1			18	19		23	24	
RTK Only 2.3				18	19	22			
RTCM/RTK 2.2	1	3		18	19	22			59
RTK Only 2.2		3		18	19	22			59
RTCM/RTK 2.1	1	3		18	19	22			59
RTK Only 2.1		3		18	19	22			59
RTCM/RTK 3.00						1004	1006	1008	1013

Message scheduling

Table B.2 describes the frequency at which messages are generated when they are enabled in a base receiver.

Table B.2 Message scheduling

Type	Frequency
1	Every second
3	The 10th second after the first measurement, then every 10 seconds after that
9-3	Every second
18	Every second
19	Every second
22	The 5th second after the first measurement, then every 10 seconds after that
23	The 4th second after the first measurement, then every 10 seconds after that
24	The 4th second after the first measurement, then every 10 seconds after that
59-sub, 13	The 5th second after the first measurement, then every 10 seconds after that
1004	Every second
1006	Every 10 seconds
1008	Every 10 seconds
1013	Every 300 seconds

Troubleshooting

In this appendix:

- LED conditions
- Receiver issues

LED conditions

An LED that is flashing quickly indicates a condition that may require attention, and an unlit LED indicates that no operation is occurring. The following table describes some LED conditions, possible causes, and how to solve them.

Condition	Possible cause	Solution
The SV Tracking LED is lit solidly and the Logging/memory LED is flashing slowly.	The receiver is in Monitor mode, ready for new firmware to be loaded or new options to be added.	Turn off or turn on the receiver. Load the latest version of the firmware, which you can download from www.trimble.com/support
The SV Tracking LED is flashing rapidly.	The receiver is tracking fewer than four satellites.	Wait until the SV Tracking LED is flashing slowly.

Receiver issues

The following table describes some possible receiver issues, possible causes, and how to solve them.

Issue	Possible cause	Solution
The receiver does not turn on.	External power too low.	Check the charge on the external battery, and check the fuse if applicable. Replace the battery if necessary.
	Internal power too low.	Check the charge on the internal batteries and replace if necessary. Ensure battery contacts are clean.
	External power not properly connected.	Check that the Lemo connection is seated properly. Check for broken or bent pins in the connector.
	Faulty power cable.	Try a different cable. Check pinouts with multimeter to ensure internal wiring is intact.
Receiver does not log data.	Insufficient internal memory.	Delete old files using the GPS Configurator or Trimble Survey Controller software, or by holding down the Power button for 30 seconds.
	The receiver is tracking fewer than four satellites.	Wait until the SV Tracking LED is flashing slowly.
The receiver is not responding.	Receiver needs soft reset.	Power down the receiver and power back up.
	Receiver needs full reset.	Hold down the Power button for 30 seconds. If you want to retain data files, remove the CompactFlash card first.

Issue	Possible cause	Solution
Reference receiver is not broadcasting.	Port settings between reference receiver and radio are incorrect.	Using the Trimble Survey Controller software, connect directly to the radio and change the port settings. Try to connect to the radio through the receiver to ensure that they are communicating.
	Faulty cable between receiver and radio.	Try a different cable. Examine the ports for missing pins. Use a multimeter to check pinouts.
	No power to radio.	If the radio has its own power supply, check the charge and connections.
Roving receiver is not receiving radio.	Reference receiver is not broadcasting.	See above.
	Incorrect over air baud rates between reference and rover.	Connect to the roving receiver's radio and check to ensure it has the same setting as the reference receiver.
	Incorrect port settings between roving external radio and receiver.	If the radio is receiving data (the Power LED is flashing) and the receiver is not getting radio communications, use Trimble Survey Controller to check that the port settings are correct.
	The cellular modem does not have hardware flow control enabled.	Disable flow control on the modem. Use a special cable. For more information, refer to the document <i>Using Cellular and CDPD Modems for RTK</i> , which is available from your Trimble Reseller.

Index

Symbols

- , (NMEA field delimiter) 62
- .cfg files 36–39
- .elf files 33
- * (NMEA checksum delimiter) 63
- \$ (NMEA start of message delimiter) 62

A

- accuracy
 - centimeter-level 16
 - submeter-level 16
- Actual Track Made Good Over and Speed Over
 - Ground message 72
- adding frequencies for internal radio 44
- antenna information, default 54
- Antenna record, in application file 36
- antennas
 - electrical interference 23
 - mounting 23
- application files
 - applying 38
 - configuring the receiver with 36
 - Current (Current.cfg) 37, 53
 - Default (Default.cfg) 37, 53
 - deleting 28
 - maximum number 37
 - naming 39
 - overview 36
 - power up (Power_up.cfg) 38, 53
 - records 36
 - storing 38
- applying application files 38
- ASCII, output, default settings 54
- Australia, notices to users 2

B

- baseline, moving 62
- battery
 - compartments 22
 - inserting in the receiver 23
- baud rate, default 54

- binary output, default settings 54
- Bluetooth wireless technology 16, 26
- bottom panel 22
- buttons 20, 28

C

- cables, data/power 59
- catch, for CompactFlash/USB door 20
- cellphones 26
- cellular modems 26, 77
- centimeter-level accuracy 16
- CMR
 - input 16
 - output 16
- COCOM limits 17
- cold start, time required 51
- CompactFlash card, upgrading receiver firmware
 - from 33
- CompactFlash port 22
- CompactFlash/USB door 22
- CompactFlash/USB door catch 20
- configuring
 - MS Series parameters 64
 - receiver in real time 36
 - receiver using application files 36
- current application file 37, 53
- current receiver configuration 37

D

- data link, using a cellular modem 26
- data outputs, NMEA 64
- data, logging to Trimble Survey Controller
 - software 31
- data/power cable pinouts 59
- default application file 37, 53
- default settings
 - antenna 54
 - ASCII output 54
 - baud rate 54
 - binary output 54
 - changing 38

- elevation mask 54
- motion 54
- NMEA output 54
- overriding 37
- receiver 53
- reference position 54
- reference station 54
- resetting 31
- RT17 output 54
- serial format 54
- streamed output 54
- SV enabling 54
- deleting files
 - application files 28
 - ephemeris file 28
- delimiters, NMEA
 - checksum 63
 - field separator 63
 - start of message 62
- Device Control record, in application file 36
- dimensions, receiver 50
- direction, NMEA field format 63
- disabling flow control 77
- dual-frequency RTK engine 16

E

- electrical interference 23
- electronic interference 16
- elevation mask, default 54
- enabling power output on Port 3 33
- environmental factors, when setting up the receiver 22
- ephemeris file, deleting 28
- Europe, notices to users 2
- European Council Directive 89/336/EEC 2

F

- factory defaults
 - receiver 53–55
 - resetting to 28, 54
- features
 - automatic OTF (on-the-fly) initialization 16
 - centimeter accuracy 16
 - CMR input and output 16
 - OTF data 16
 - real-time positioning 16
 - receiver 16
 - RTCM SC-104 input and output 16

- RTK data 16
 - submeter accuracy 16
 - WAAS capability 16
- File Storage record, in application file 36
- firmware, upgrading 33, 43
- flashing LED 29
- flow control
 - default setting 54
 - disabling on cellular modem 26, 77
 - receiver 51
- frequencies, for internal radio 44
- front panel 20
- full reset 76

G

- General Controls record, in application file 36
- GGA message, time, position, and fix related data 64
- GPS antenna port 16
- GPS Configurator software
 - installing 42
 - Trimble R6/R8 receiver 25, 35, 42
- GSA message 65
- GST message 66
- GSV message 66
- guidelines for setting up receiver 23

H

- Heading Information message 70

I

- icons, on top panel 21
- indicator LEDs 20, 29
- initialization
 - minimum time required 51
 - on-the-fly 16
 - specifications 51
- input
 - CMR 16
 - RTCM 16
- Input Message record, in application file 36
- installing
 - GPS Configurator software 42
 - WinFlash utility 43
- interference
 - electrical 23
 - electronic 16
- internal radio

adding frequencies 44
internal radio, receiver 25

L

latitude, NMEA field format 63
LEDs
 flashing 29
 receiver 20, 29
Lemo cables, plugging in 23
limits, imposed by COCOM 17
Local Coordinate Position Output message 69
Logging Rate record, in application file 36
logging to Trimble Survey Controller software 31
longitude, NMEA field format 63

M

maximum number of application files 37
Maxwell architecture 51
memory, full 76
message ID, in NMEA messages 63
mobile phones 26
Monitor mode 33, 76
motion, default settings 54
mounting antenna, avoiding electrical interference 23

N

naming application files 39
New Zealand, notices to users 2
NMEA
 output 16, 61–72
 output, default settings 54
NMEA messages
 common elements 62
 common message elements 63
 delimiters 63
 enabling and disabling 62
 GGA 64
 GSA 65
 GST 66
 GSV 66
 ID 63
 PTNL,GGK 67
 PTNL,GGK_SYNC 68
 PTNL,PJK 69
 PTNL,PJT 69
 PTNL,VGK 70

PTNL,VHD 70
summary 62
values 63
VTG 72
ZDA 72

notices to users
 Australia and New Zealand 2
 Europe 2

O

on-the-fly (OTF) initialization 16
operating controls 20
operating near other radio equipment 6
operating temperature 50
other radio equipment, operating near 6
output formats
 CMR 16
 NMEA 16, 61
 RT17 51, 54
 RTCM 16
 Trimble R6/R8 receiver 51
Output Message record, in application file 36
overriding default settings 37

P

physical specifications 50
pinout information, receiver 57
pinouts
 data/power cable 59
 serial ports 58
pole-mounted setup, receiver 23
Port 1
 default baud rate 54
 default serial format 54
 flow control 54
 icon 21
 pinout diagram 58
 power output 33
Port 2
 default baud rate 54
 default serial format 54
 icon 21
 pinout diagram 58
Port 3
 flow control 54
 power output 33
port settings, checking 77
ports, receiver pinout diagram 58

Position Error Statistics message 66
Power button 28
power cable, pinouts 59
power output
 enabling on Port 3 33
 on Port 1 33
power supply 31
power up application file
 overriding factory defaults with 53
 Trimble R6/R8 receiver 38
Power_Up.cfg *See* power up application file 53
problems, troubleshooting 75
Projection Type message 69
PTNL,GGK message 67
PTNL,GGK message, Time, Position, Position Type,
 DOP 67
PTNL,GGK_SYNC message 68
PTNL,PJK message 69
PTNL,PJT message 69
PTNL,VGK message 70
PTNL,VHD message 70

R

radio antenna port 16
radio noise emissions, Canada 2
RADIO port icon 21
radios
 internal 25
 Trimble R6/R8 receiver 25
 TRIMMARK 3 25
real time, configuring receiver in 36
rear panel 21
receiver
 buttons 28
 catch lock 21
 changing default settings 38
 configuring 35
 connecting to devices 57
 current configuration 37
 factory default settings 53
 inserting the internal battery 23
 internal radio 25
 LEDs 29
 maximum number of application files 37
 output formats 51
 parts of the receiver 20–22
 pole-mounted setup 23
 resetting 37
 resetting to factory defaults 28, 54
 setup 19–26

 specifications 49–51
 turning on and off 28, 29
 upgrading firmware 33, 43
 use and care 16
receiver setup 19–26
Reference Position record, in application file 36
reference position, default 54
reference station, default settings 54
registration 13
release notes 13
reset
 full 76
 soft 76
 to factory defaults 28, 54
 Trimble R6/R8 receiver 37
RT17 output
 default settings 54
 Trimble R6/R8 receiver 51
RTCM input 16
RTCM output 16
RTK engine 16
RTK/OTF data 16

S

Satellite Information message 66
security limits 17
serial format, default setting 54
Serial Port Baud/Format record, in application file 36
serial ports pinouts 58
setup
 guidelines 22
 pole-mounted 23
 Trimble R6/R8 receiver 19–26
signal processing 51
size, receiver 50
soft reset 76
specifications
 physical 50
 receiver 49–51
 technical 51
start-up specifications 51
Static/Kinematic record, in application file 36
storage temperature 50
storing application files 38
streamed output, default settings 54
submeter-level accuracy 16
SV Enable/Disable record, in application file 36
SV enabling, default settings 54

T

- technical specifications 51
- temperature
 - operating range 50
 - storage range 50
- time values in NMEA messages 63
- Time, Position, and Fix Related Data message 64
- Time, Position, and Fix Related Data, GGA message 64
- Time, Position, Position Type, DOP message 67
- Time, Synchronized Position, Position Type, DOP message 68
- TNC connector 16
- TNC ports 16
- tracking specifications 51
- Trimble Survey Controller software
 - configuring the internal radio with 25
 - configuring the receiver with 35
- Trimble web site 13
- TRIMMARK 3 radio 25
- troubleshooting 75
- turning the receiver on and off 28, 29

U

- U.S. Department of Commerce 17
- Universal Time Coordinated (UTC) *See* UTC
- upgrading receiver firmware 33, 43
- USB port 22
- use and care of the receiver 16
- UTC Day, Month, and Year, and Local Time Zone Offset message 72
- UTC, NMEA time values 63

V

- Vector Information message 70
- VTG message 72

W

- WAAS, receiver 16
- warm start, time required 51
- website 13
- weight, receiver 50
- WinFlash utility
 - installing 43
 - receiver 25, 43
 - upgrading receiver firmware with 43

Z

- ZDA message 72

